

PowerHill

User Manual

About This Document

Purpose

This document describes the installation, electrical connections, commissioning, and troubleshooting of PowerHill series battery energy storage systems (also referred to as BESS). Before installing and operating the PowerHill BESS, read this document carefully to understand the safety information as well as functions and features of the BESS.

Application Scope of Manual

This manual is suitable for transportation, assembly, installation and commissioning. The product models of PowerHill outdoor energy storage system are shown in the table.

PowerHill-P30-143kWh, PowerHill-P30-179kWh, PowerHill-P60-143kWh,
PowerHill-P60-161kWh, PowerHill-P60-179kWh, PowerHill-P60-215kWh
PowerHill-P100-215kWh

Intended Audience

This document is intended for:

- Technical support engineers
- Hardware installation engineers
- Commissioning engineers
- Maintenance engineer

Terminology+

Abbreviation	Connotation
BESS	Battery Energy Storage System
BMS	Battery Management System
EMS	Energy Management System
SOC	State of Charge
SOH	State of Health
AC	Alternating Current
DC	Direct Current
PCS	Power Conversion System
DOD	Depth of Discharge

MPPT	Maximum Power Point Tracking
------	------------------------------

Contents

About This Document.....	I
Contents.....	III
1 Safety Information.....	1
1.1 Safety Requirements.....	1
1.2 Safety Label.....	2
1.3 Safety Warning.....	3
2 Product Overview	4
2.1 System Introduction	4
2.2 Configuration.....	6
2.3 Appearance and Dimensions	2
2.4 Components	3
2.5 Technical Specification.....	6
2.6 Working Modes	7
3 Key Components	8
3.1 Battery Pack	8
3.2 Control Box.....	9
3.3 EMS.....	10
3.4 PCS-Power Conversion System	12
3.5 MPPT (optional)	15
3.6 DCDC	17
3.7 Fire Suppression system.....	19
3.8 Air conditioning system	22
4 Installation	24
4.1 Installation Preparation	24
4.2 Unpacking and Acceptance.....	41
4.3 Installation.....	44
4.4 Connection a ground cable for the ESS	45
4.5 Installing cables	46
4.6 Check After Installation	55
5 Powering-On the PowerHill Product.....	56
5.1 Check Before Power-On	56
5.2 Power On Process	57
5.3 BESS Power-off Procedure.....	60

6	Commissioning	63
6.1	Local Startup.....	63
6.2	Communication Configuration	63
6.3	Scheduling Instructions.....	65
7	Human-Computer Interaction.....	66
7.1	Local Use.....	66
7.2	External devices via network cable connection	83
8	Contact details.....	88

1 Safety Information

1.1 Safety Requirements

The PoweHill BESS has been designed and tested strictly according to international safety regulations. Read all safety instructions carefully prior to any work and always observe them when working on or with the PoweHill BESS. Incorrect operation or work may cause:

- Injury or death to the operator or a third party.
- Damage to the inverter or other properties.

General Requirements

- Do not stop protective devices. Pay attention to the warnings, cautions, and related precautionary measures in this document and on the equipment.
- If there is a likelihood of personal injury or equipment damage during operations, immediately stop, report the case to the supervisor, and take feasible protective measures.
- Do not power on the equipment before it is installed or confirmed by professionals.
- Do not touch the power supply equipment directly or with conductors such as damp objects. Before touching any conductor surface or terminal, measure the voltage at the contact point to ensure that there is no risk of electric shock.
- Do not touch operating equipment because the enclosure is hot.
- Do not touch a running fan with your hands, components, screws, tools, or boards. Otherwise, personal injury or equipment damage may occur.
- In the case of a fire, immediately leave the building or the equipment area and activate the

fire alarm or call emergency services. Do not enter the affected building or equipment area under any circumstances.

Electrical Safety

- Before commissioning and switching off the disconnecting circuit breaker, all basic information and step-by-step instructions must be understood and the safety instructions for the installation must be strictly adhered to.
- Do not change the size or rating of the fuse.
- When the device is connected to a power source, a safety officer must be appointed to ensure that the disconnected switch is not closed during maintenance.
- During the wiring process, two or more operators are not allowed to connect a wire at the same time.





1. 2 Safety Label

The operator must read and understand the labels attached on the BESS cabinet before performing any operations.



Fig. 1-1 Safety Stickers

1. 3 Safety Warning

 DANGER!	<p>'Danger' indicates a hazard with a high level of risk that, if not avoided, will result in death or serious injury.</p>
 WARNING!	<p>'Warning' indicates a hazard with a medium level of risk that, if not avoided, will result in death or serious injury.</p>
 CAUTION!	<p>'Caution' indicates a hazard with a low level of risk that, if not avoided, could result in minor or moderate injury.</p>
NOTICE NOTICE!	<p>'Notice' indicates a situation that, if not avoided, could result in equipment or property damage.</p>
 NOTE!	<p>'Note' provides tips that are valuable for the optimal operation of the product.</p>

2 Product Overview

2.1 System Introduction

PowerHill BESS is an integrated energy storage outdoor cabinet solution that includes batteries, BMS, PCS, MPPT, auxiliary power system, fire suppression system, air conditioning system, and grounding system.

PowerHill can be connected to photovoltaic equipment and has off-grid application scenarios. It can store the electric energy generated by the photovoltaic system and release it when needed to achieve energy balance and peak-shaving and valley-filling. At the same time, it can also be used as an emergency backup power supply to provide reliable power supply.

The application topology of the system is shown below:

On-Grid/Manual On &Off- Grid Topology:

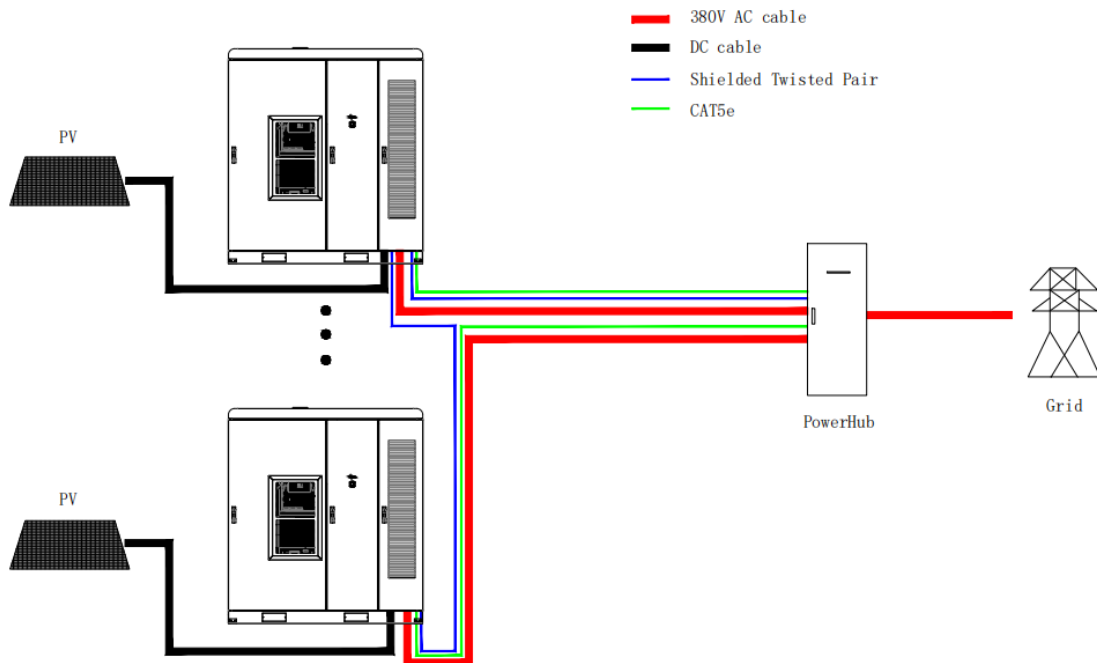

Fig. 2-1 BESS On&Off-Grid Topology

Automatic On &Off- Grid Topology:

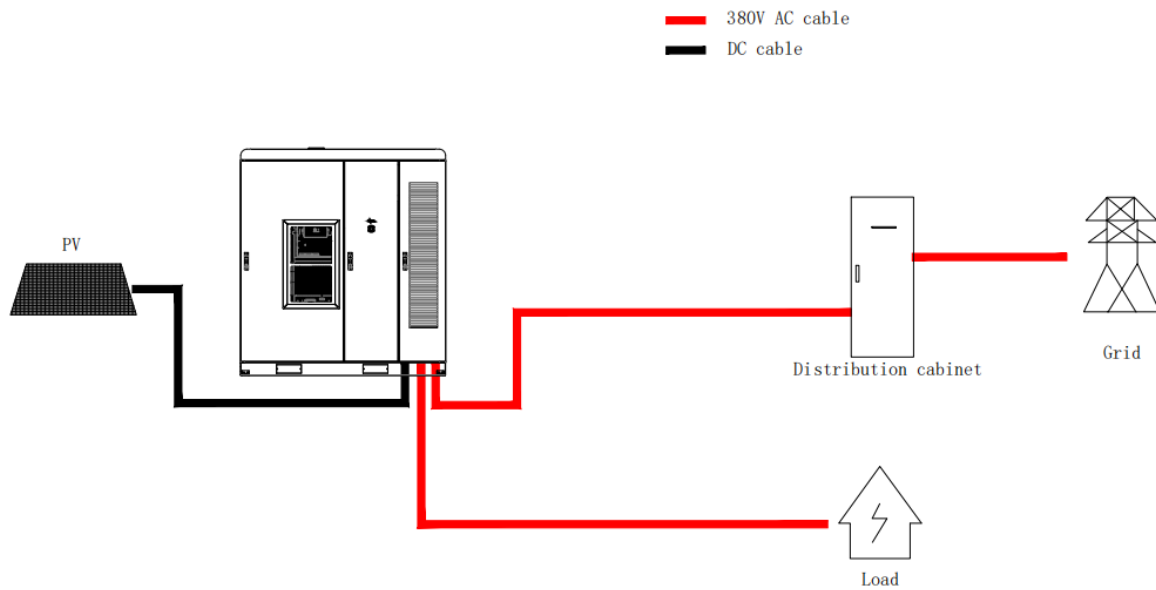

Fig. 2-2 BESS Automatic On&Off-Grid Topology

※Note: MPPT is optional.

- Battery and BMS systems are used to store electrical energy.
- PCS is used for AC/DC conversion.
- MPPT is used for photovoltaic charging.
- The auxiliary power system provides power to all equipment inside the BESS.
- Firefighting system is the protection for the operators and the BESS in the event of a fire.
- Air conditioner is used to regulate the temperature inside the BESS.
- Grounding system is the safety guarantee of BESS.

2.2 Configuration

PCS, DCDC, MPPT configuration instruction:

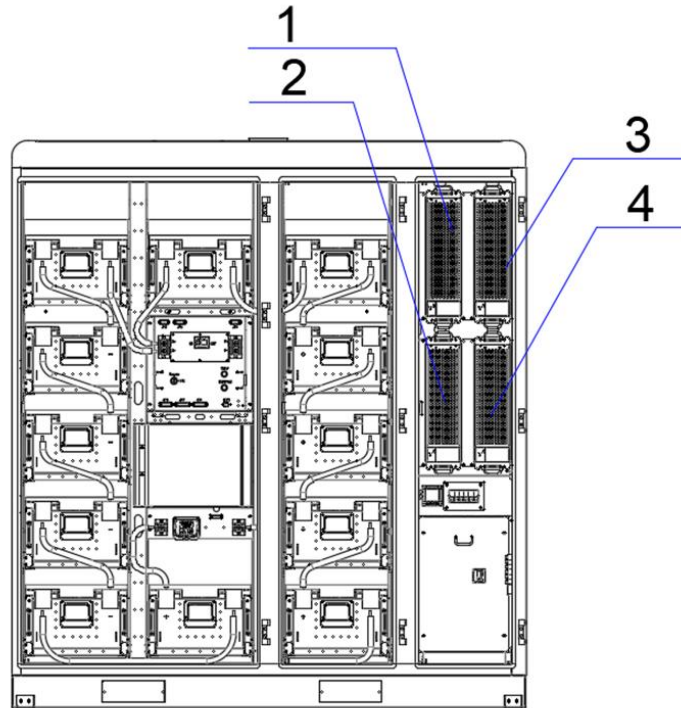

Fig. 2- PowerHill module configuration

Specification	Configuration instructions	Module Position
PowerHill-P30-143kWh	30kW PCS, MPPT not configured, capacity of 143kWh	PCS: 4
PowerHill-P30-179kWh	30kW PCS, 30kW MPPT, capacity of 179kWh	PCS: 4; MPPT: 2(optional)
PowerHill-P60-143kWh	60kW PCS, 30/60kW MPPT, capacity of 143kWh	PCS: 4; MPPT: 1、3/3(optional)
PowerHill-P60-161kWh	60kW PCS, 30/60kW MPPT, capacity of 161kWh	PCS: 4 MPPT: 1、3/3(optional)
PowerHill-P60-179kWh	60kW PCS, 30/60kW MPPT, capacity of 179kWh	PCS: 4 MPPT: 1、3/3(optional)
PowerHill-P60-215kWh	60kW PCS, 30/60kW MPPT, capacity of 179kWh	PCS: 4 MPPT: 1、3/3(optional)
PowerHill-P100-215kWh	100kW PCS, 100kW MPPT, capacity of 215kWh	PCS: 2、4 MPPT: 1、3(optional)

Battery PACK and capacity configuration instruction:

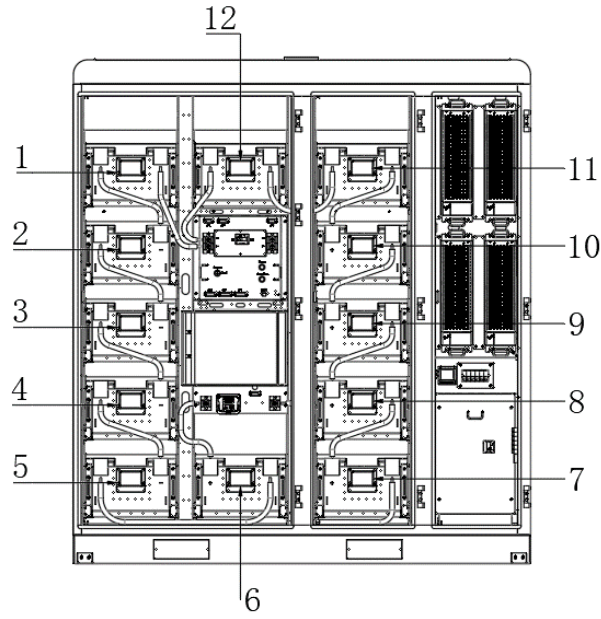

Fig. 2-2 PowerHill PACK location

Product	Capacity (kWh)	Pack Quantity (Piece)	Pack Position
PowerHill	143.36	8	Pack3 to Pack10
	161.2	9	Pack2 to Pack10
	179.2	10	Pack2 to Pack11
	197.12	11	Pack1 to Pack11
	215.04	12	Pack1 to Pack12

2.3 Appearance and Dimensions

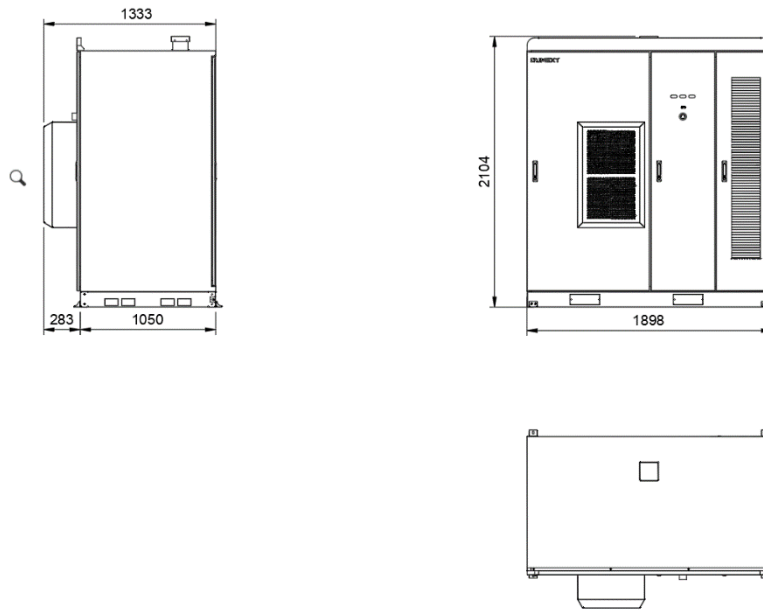

Fig. 2-3 PowerHill Appearance and Dimensions

Table 2-1 Cabinet Dimensions

BESS				
Name	Width(mm)	Depth(mm)	Height(mm)	Weight(kg)
Outdoor Energy Storage Cabinet	1898	1333	2104	About 2500

2. 4 Components

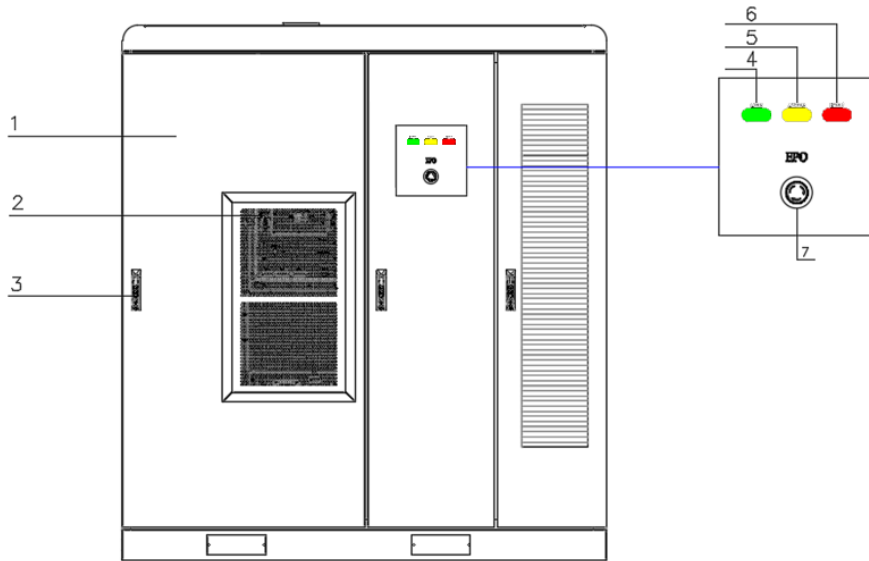

Fig. 2-4 Front view of PowerHill (doors closed)

Item	Name	Description	Remark
1	Cabinet	BESS Shell	
2	Air Conditioner	Adjust the temperature inside the outdoor cabinet	
3	Door Lock	Lock the cabinet, requires a specific key to open	
4	Running Indicator	Steady green indicates BESS is normal, Blinking green indicates standby	
5	Alarm Indicator	Steady yellow indicates a warning or alarm is generated	
6	Fault Indicator	Steady red indicates that there is a fault in the system and the system stops running.	
7	Emergency Stop	For emergency use	

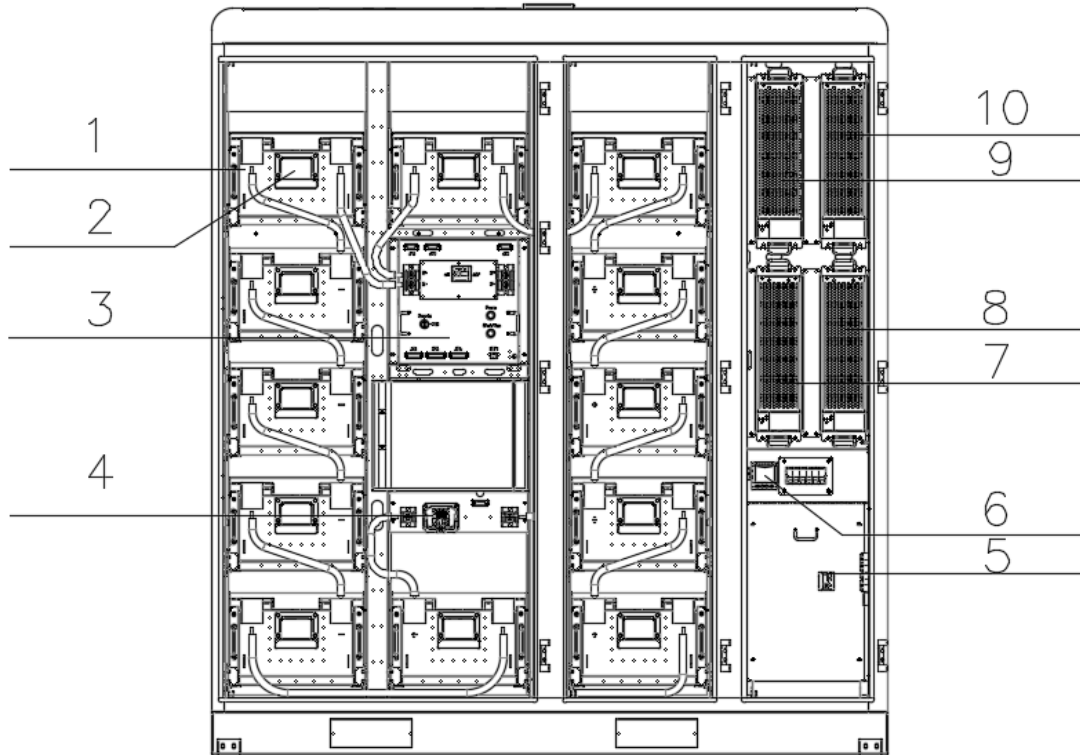

Fig. 2-5 Front interior illustration of the BESS

Item	Name	Description	Remark
1	Battery Pack	For energy storage	The number of batteries is subject to the actual product
2	BMM	Battery pack monitoring module	
3	Control box	BMS inside, real-time monitoring of battery status	
4	O&M DC Switch	Disconnect the DC bus	
5	AC circuit breaker	Main switch for AC power distribution	
6	Meter	Power meter for the AC side	
7	PCS	For AC/DC conversion	
8	PCS	For AC/DC conversion	
9	MPPT	For photovoltaic connection	Optional
10	MPPT	For photovoltaic connection	Optional

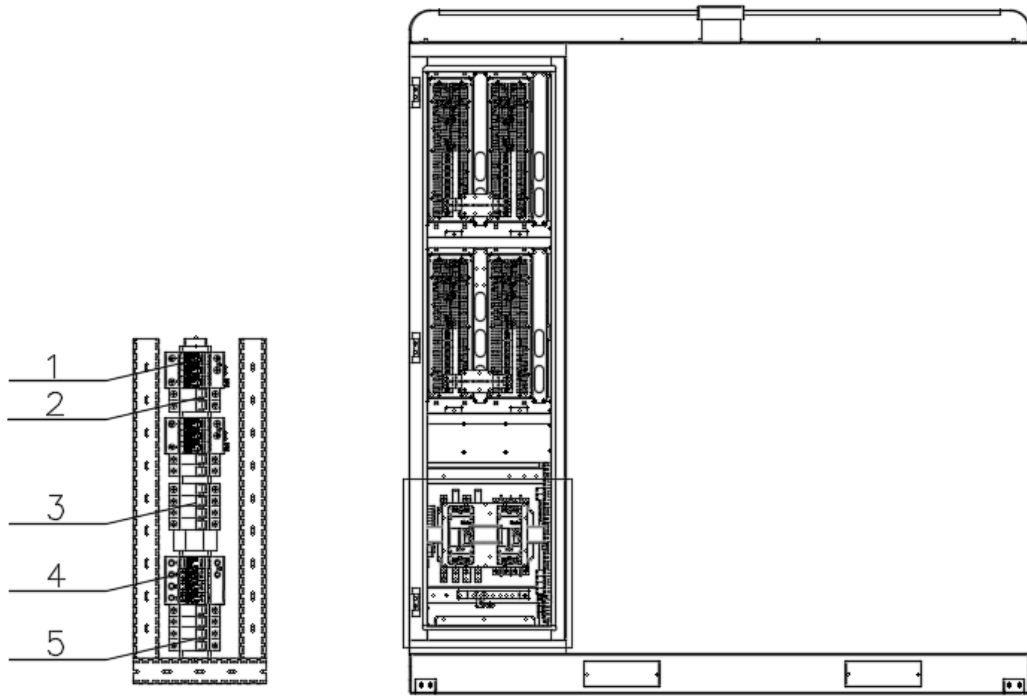

Fig. 2-6 the back of the BESS

Item	Name	Function	Remark
1	PV SPD	PV DC side surge protection	Optional
2	DC Fuse	PV DC side overcurrent protection	Optional
3	AC Fuse	Overcurrent protection for the fan	
4	AC SPD	AC side surge protection	
5	AC Circuit breaker	Used to protect against short circuits	

2.5 Technical Specification

Model	PowerHill-P30-143kWh	PowerHill-P30-179 kWh	PowerHill-P60-143 kWh	PowerHill-P60-161 kWh	PowerHill-P60-179 kWh	PowerHill-P60-215 kWh	PowerHill-P100-215 kWh
Battery							
Cell type	LFP-280Ah						
Pack configuration	IP20S						
Battery capacity	143.33kWh	179.16kWh	143.33kWh	161.24kWh	179.16kWh	215kWh	215kWh
AC Output							
Connection type	3P4W						
Charging / discharging power(KW)	30		60			100	
Rated grid voltage(V)	220/380;230/400						
Frequency (Hz)	50/60						
Rated AC output current (A)	43		86			144	
Adjustable power factor range	0.8 (Leading)...0.8 (Lagging)						
Harmonics	≤3% (Rated) THD						
Backup output(Off Grid)							
Connection type	3P4W						
Rated output power (KW)	30		60			100	
Rated output voltage (V)	220/380;230/400						
Output frequency(Hz)	50/60						
Rated current(A)	43		86			144	
Frequency accuracy	0.2Hz						
General Parameters							
Dimensions (W*H*D) (mm)	1900*2100*1330						
Packing size(W*H*D)(mm)	2100mm*2244mm*1500mm						
Weight(Kg)	~2500k						
Degree of protection	IP55 (Battery Cabinet) IP34 (Electrical Cabinet)						
Cooling method	Battery Cabinet (air conditioner)						
Fire suppression system	FM200 automatic fire extinguishing						
Anti-corrosion grade	C3						
Relative humidity	0-95% (non-condensing)						
Operating temperature*(°C)	-20 ~ 50						
Altitude**(m)	< 2000						
Noise level(dB)	≤75						
Communication interface	RS485, Ethernet						
Communication protocol	Modbus RTU, Modbus TCP/IP						
PV Side Parameters (Optional)							
Max. PV input power(KW)	30/60		30/60/90/120				
MPPT voltage range(V)	200~850						
Number of MPPTs	1/1		1/1/2/2				
Number of PV inputs	1/1		1/1/2/2				
Maximum input current(A)	100/200		100/200/300/400				
Certifications	CE(IEC61000,IEC62619,IEC62477),UN3480,UN38.3,MSDS						
	Converter:UK G99,VDE4105,EN50549						

	Cell:IEC62619,UL1973,UL1642,UL9540A
[1] The system will be derated when the ambient temperature exceeds 45°C.	
[2] The system will be derated when the altitude is between 2000 and 3000m.	

2. 6 Working Modes

Mode	Description
On-Grid	In on-grid mode, the battery energy storage system is connected to the grid and achieves two-way energy flow with the grid.
Off-Grid in Manual	In manual off-grid mode, users can choose to disconnect the battery energy storage system from the grid to achieve independent operation.
Smooth photovoltaic mode	The smooth photovoltaic mode of energy storage combines energy storage technology with photovoltaic power generation to solve the problems of photovoltaic system power fluctuation and intermittency. Convert solar energy into electrical energy through photovoltaic modules and store excess electrical energy. When power is needed, the energy storage system releases the stored power to meet the demand, and achieves smooth power output through electronic control equipment and smoothly injects it into the grid.
Backup mode	The backup mode of energy storage refers to the mode of operation in which energy storage devices are used as backup power sources. When the main grid power supply is unstable or interrupted, the energy storage system will automatically start to convert the stored electrical energy into electricity to provide emergency power support for key equipment or the entire grid.
Peak and valley mode	In this mode, the system stores energy when electricity prices are low, and the stored electricity is used when electricity prices are high.

* Off-grid function needs to be switched manually after disconnecting from the grid.

* Connecting three-phase, three-wire loads are not supported; if the load carried by the device in off-grid mode is capacities or inductive, the carrying capacity of PowerHill is within 25% of the rated power.

3 Key Components

3.1 Battery Pack

	Danger:
	<ul style="list-style-type: none"> ● Do not touch any batteries when BESS is running. ● Only authorized operators can operate the battery. ● End of life (decommissioning, dismantling and disposal in accordance with the provided recycling program).

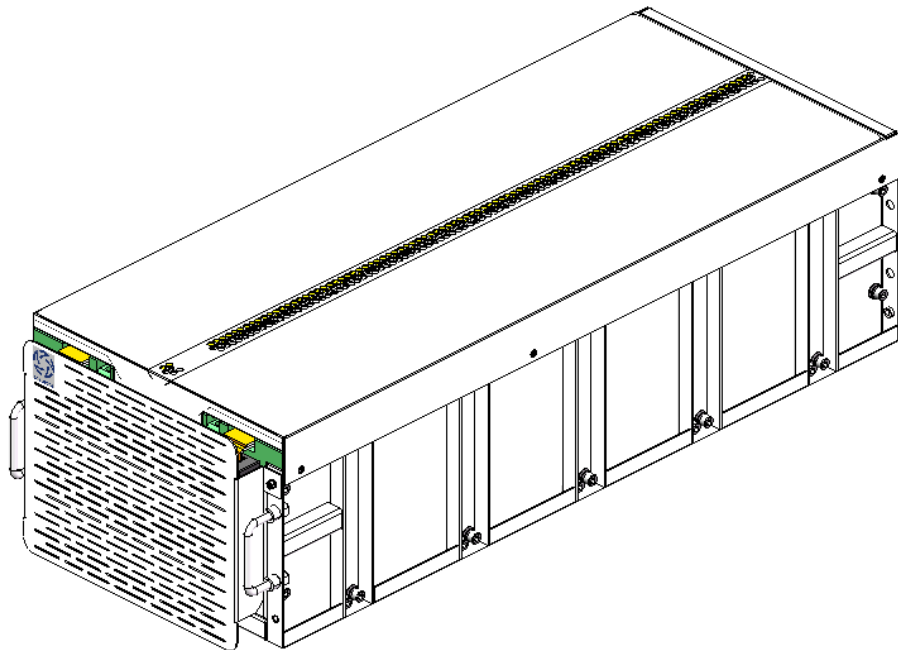

Fig. 3-1 Diagram of the battery module

Project	Specifications
Rated voltage	64V
Rated capacity	280Ah 17920Wh
Dimensions	378*985*260(W*D*H)

Weight	150kg
Composition	1P20S
Standard charging current	140A
Standard discharge current	140A
Charge termination voltage	3.6V/Cell
Discharge termination voltage	2.8V/Cell
Working environment temperature	Charge: 0°C ~ +60°C, Discharge: -30°C ~ +60°C
Storage temperature	Short-term storage: -20°C ~ +45°C (<1 month SOC:20%~60%) Long-term storage: 0°C ~ +35°C (<1 year SOC:30%~60%)
Storage humidity	5% to 95%
Long-term storage requirements	6 months ambient power supply: charge and discharge once, then reverse charge to 25% SOC

3. 2 Control Box

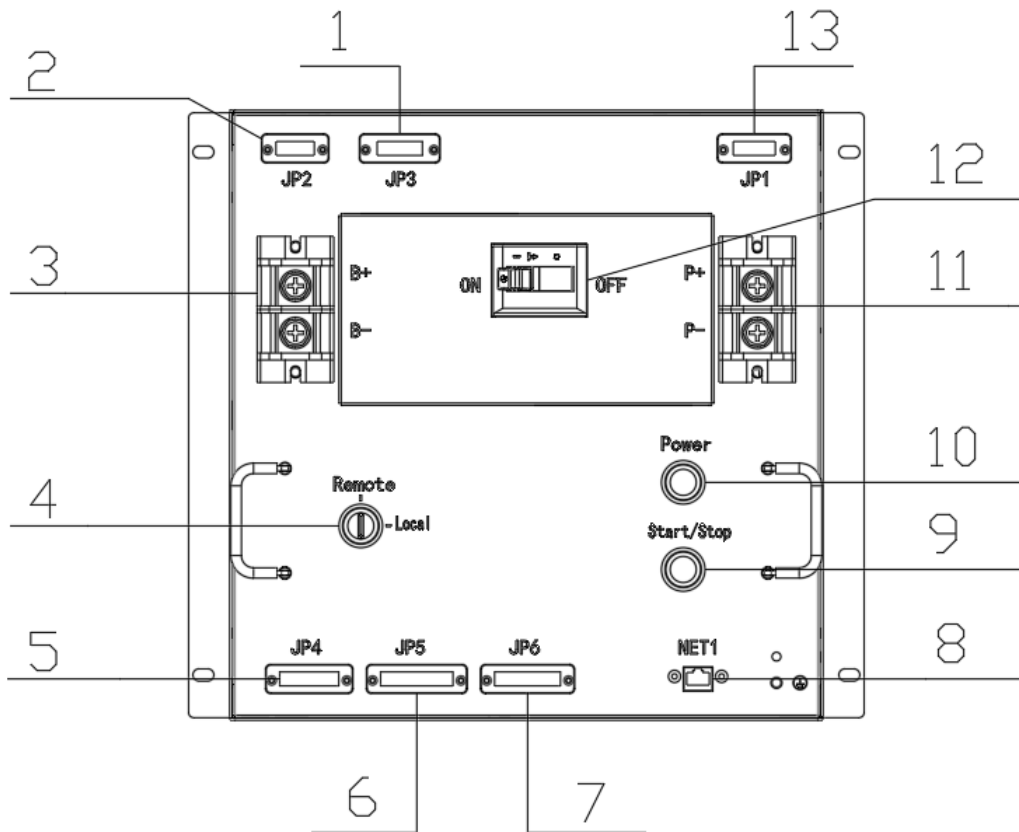

Fig. 3-2 Control Box Panel

Item	Name	Description
1	JP3	DC contactor control and feedback signals, maintenance switch feedback signals
2	JP2	CAN/12V power supply of BMM
3	DC bus+/-	Battery Connection, DC bus+/-
4	Mode switch	Remote/local mode switching
5	JP4	Power supply for indicator
6	JP5	RS485 communication
7	JP6	CAN communication, fire battery valve control
8	NET1	External communication RJ45 port
9	Start/stop button	Local mode, start and stop
10	Power switch	Power supply
11	P+/P-	PCS DC positive and negative connection terminal
12	DC circuit breaker	Battery Main Circuit Breaker
13	JP1	DC, battery powered

3.3 EMS

(1) EMS appearance and components:

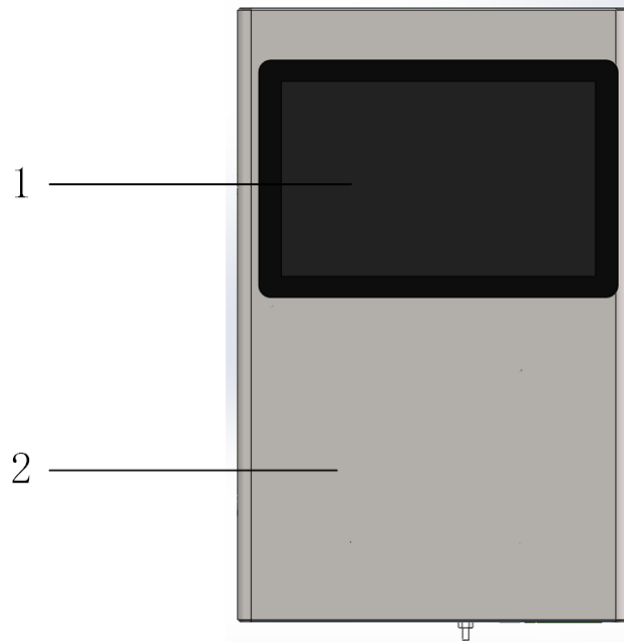

Fig. 3-3 Appearance of EMS

Item	Name	Function	Remark
1	Display	Display EMS interface information	
2	EMS box	Cabinet	

(2) Parameters:

Project	Specifications	Illustrate
Control function	Peak and valley mode, backup mode, smooth photovoltaic	
PCS module quantity	12	
Number of BMS clusters	6	
System rated power	600kW	
User interface	Display interface, Ethernet	
Communication Interface	1 way Ethernet	
Letter of agreement	Ethernet: Modbus TCP	
Power input	DC12V	
Working temperature	-20~55℃	
Altitude	≤2000m	
Ambient relative humidity	5~95%	No condensation
Protection level	IP21	
Width* Height* Depth	320mm*500mm*60mm	
Weight	9.3kg	
Installation method	Indoor, hanging installation	

(3) Function list:

Item	Function	Describe
1	System start and stop control	It can control the start and stop operations of the battery energy storage system, and decide whether to put the system into use or suspend operation according to needs.
2	System power delivery	With the ability to issue power commands, the power output of the system can be adjusted as needed to meet changes in power demand.
3	System operating mode switching	Supports switching between different operating modes, such as grid-connected mode, independent operating mode or hybrid mode, to adapt to different application scenarios and needs.
4	System data query	Provides a query function to obtain real-time data, historical data, status information and operating parameters of the battery energy storage system to monitor and evaluate the performance and operation of the system.
5	System data export	Supports exporting system data to external devices or storage media for further analysis, recording, or report generation.
6	System control switch	The control switching function allows the control of the system to be transferred from one control device or system to another to achieve flexibility and reliability in monitoring, management and operation.

3. 4 PCS-Power Conversion System



Fig. 3-4 Front panel (Remove the dust cover)

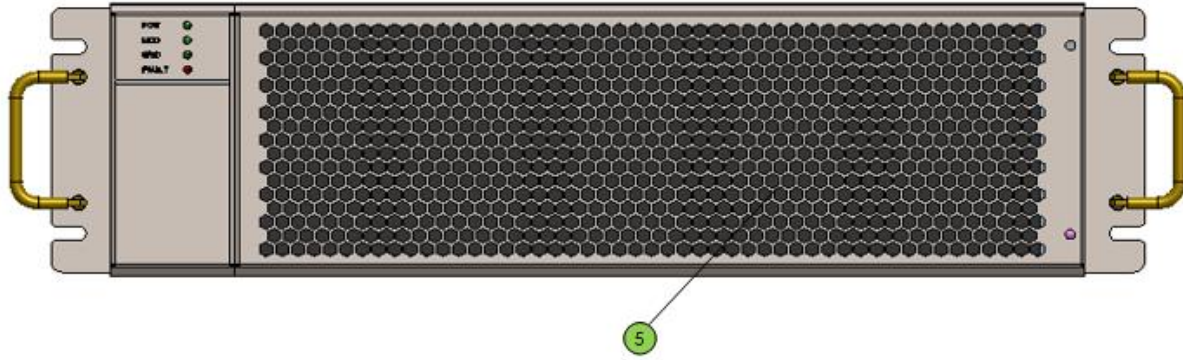

Fig. 3-5 Front Panel

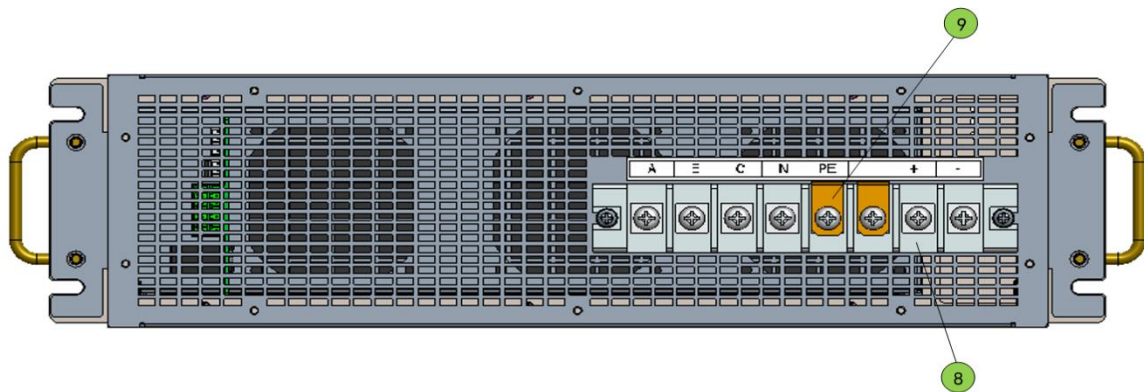

Fig. 3-6 Back panel

- ① LED Status Indicator
- ② Communication resistance DIP switch
- ③ RJ45 Communication Interface
- ④ BMS & EMS Communication Interface
- ⑤ Dust Cover
- ⑥ Parallel Communication Interface
- ⑦ RS485&DI/DO Signal Interface
- ⑧ DC&AC Terminals
- ⑨ PE Short circuit metal sheet

Model		MA1000K30	MA1000K60
DC parameter s	Maximum voltage [Vd.c.]	1000	1000
	Rated voltage [Vd.c.]	800	800
	Battery voltage range [Vd.c.]	680~1000	680~1000
	Maximum charging / discharging current [Ad.c.]	44	88
AC input parameter s	Maximum input apparent power [kVA]	30	60
	Maximum input active power [kW]	30	60
	Rated input voltage [Va.c.]	230/400, 3P+N+PE	230/400, 3P+N+PE

	Maximum continuous input current [Aa.c.]	43	86
	Rated input frequency [Hz]	50	50
AC output parameters	Rated output voltage [Va.c.]	230/400, 3P+N+PE	230/400, 3P+N+PE
	Rated output frequency [Hz]	50	50
	Maximum continuous output current [Aa.c.]	43	86
	Maximum continuous output active power [kW]	30	60
	Maximum continuous output apparent power [kVA]	30	60
	unbalanced loads	100%	100%
	Overload capacity	1.1 1min;1.2 5s	1.1 1min;1.2 5s
	Power factor	0.8 un~0.8 ov	0.8 un~0.8 ov
	General	Operating temperature range [°C]	-30~+60 (>45°C derating)
Ingress protection		IP20	IP20
Operating altitude range [m]		3000	3000
Maximum efficiency		98.5%	98.5%
AC / DC start function		Integrated	Integrated
Size (W*D*H) [mm]		436*550*130	436*550*130
Weight [kg]		25	28
Communication	BMS communication interface	CAN、RS485	CAN、RS485
	EMS communication interface	Ethernet、RS485	Ethernet、RS485
	EMS communication protocol	ModbusTCP/ModbusRTU	ModbusTCP/ModbusRTU
	general-purpose IO	3-way DI、2-wayDO	3-way DI、2-wayDO

3.5 MPPT (optional)



Fig. 3-7 Front panel (Remove the dust cover)

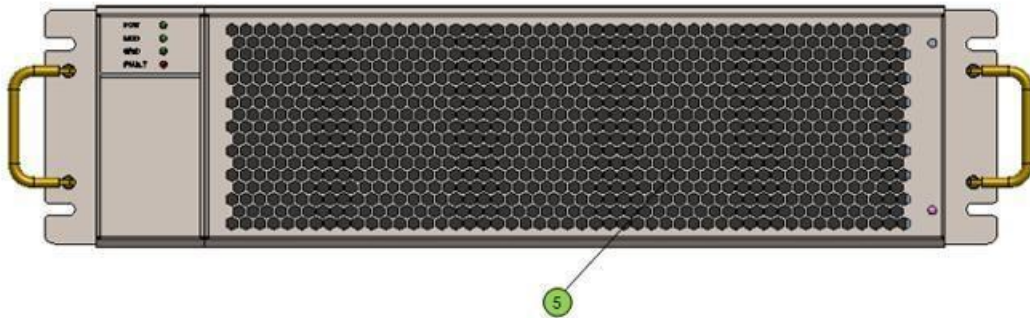

Fig. 3-8 Front Panel

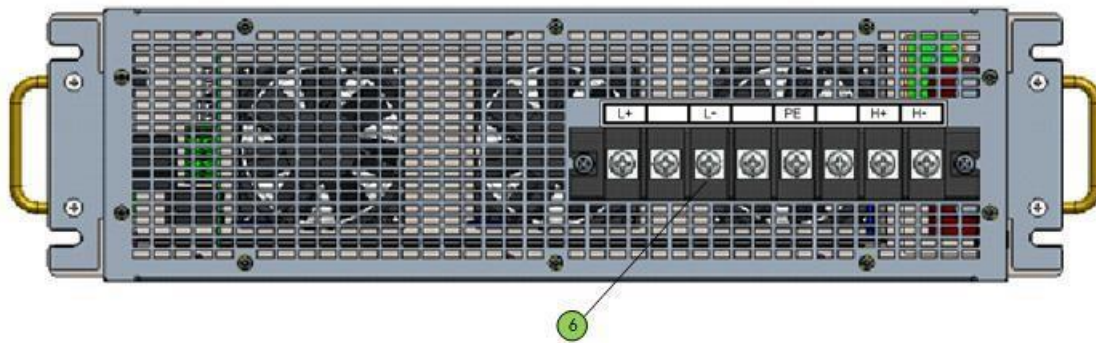

Fig. 3-9 Back panel(30kW)

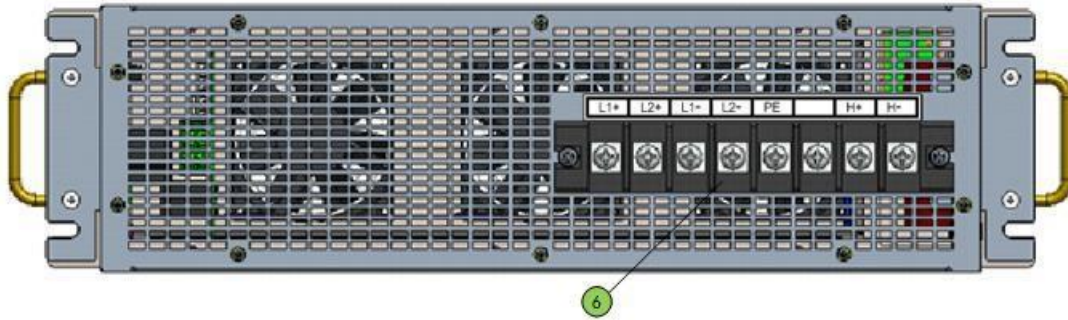

Fig. 3-10 Back panel(60kW)

- ① LED Status Indicator
- ② Communication resistance DIP switch
- ③ Module communication and DI/DO interface
- ④ Parallel Communication Interface
- ⑤ Dust Cover
- ⑥ Input and output
- ⑦ RS485&DI/DO Signal Interface
- ⑧ DC&AC Terminals
- ⑨ PE Short circuit metal sheet

Model		MPPT30A	MPPT60A
PV terminal parameters:	Maximum PV array voltage [Vd.c.]	1000	1000
	Maximum Input power [kW]	30	60
	MPPT voltage range [Vd.c.]	200~850	200~850
	MPPT number	1	1
	MPPT Input number	1	1
	Maximum Input current [Ad.c.]	100	200
HV terminal parameters:	Maximum voltage [Vd.c.]	1000	1000
	Rated voltage [Vd.c.]	800	800
	Voltage range [Vd.c.]	350~1000	350~1000
	Maximum continuous current [Ad.c.]	50	100
	Maximum continuous power [kW]	30	60
General	Operating temperature range [°C]	-30~+60 (>45°C derating)	-30~+60 (>45°C derating)
	Ingress protection	IP20	IP20
	Operating altitude range [m]	3000	3000
	Maximum efficiency	98.5%	98.5%
	HV / LV start function	Integrated	Integrated
	Size (W*D*H) [mm]	436*550*130	436*550*130
	Weight [kg]	25	28

3. 6 DCDC Module



Fig. 3-11 Front panel (Remove the dust cover)

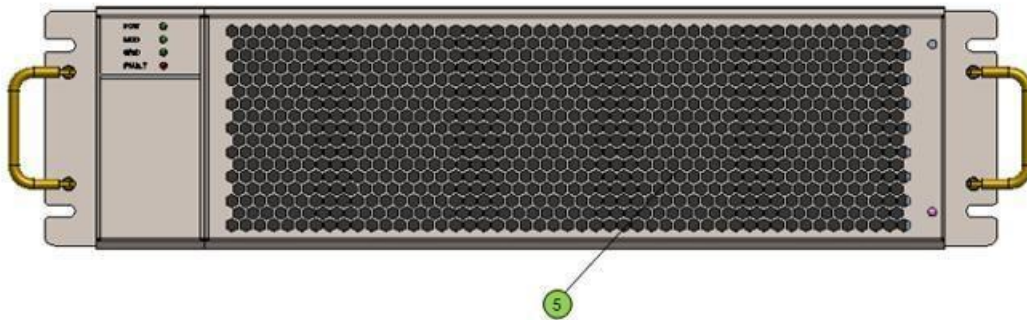

Fig. 3-12 Front Panel

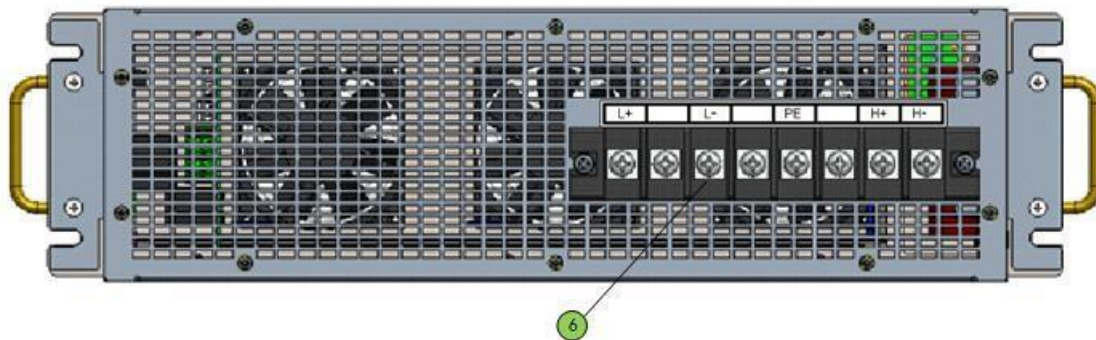

Fig. 3-13 Back panel(30kW)

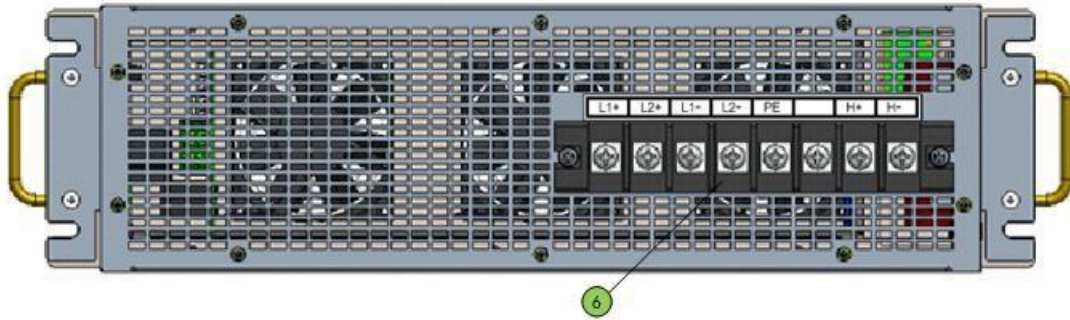

Fig. 3-14 Back panel(60kW)

- ① LED Status Indicator
- ② Communication resistance DIP switch
- ③ Module communication and DI/DO interface
- ④ Parallel Communication Interface
- ⑤ Dust Cover
- ⑥ Input and output
- ⑦ RS485&DI/DO Signal Interface
- ⑧ DC&AC Terminals
- ⑨ PE Short circuit metal sheet

The DC/DC module is a device used for DC-DC voltage conversion. Its main function is to convert the DC voltage of the input power supply into the required output voltage to meet the power supply voltage requirements of the equipment.

DC/DC modules is pre-installed in factory when the battery pack is less than 12.

Model		MD1000K30	MD1000K60
Battery terminal parameters:	Maximum voltage [Vd.c.]	900	900
	Rated voltage [Vd.c.]	350	350
	Battery voltage range [Vd.c.]	200~900	200~900
	Maximum charging / discharging power [kW]	30	60
	Maximum charging / discharging current [Ad.c.]	100	200
HV terminal parameters:	Maximum voltage [Vd.c.]	1000	1000
	Rated voltage [Vd.c.]	800	800
	Voltage range [Vd.c.]	350~1000	350~1000
	Maximum continuous current [Ad.c.]	50	100
	Maximum continuous power [kW]	30	60
General	Operating temperature range [°C]	-30~+60 (>45°C derating)	-30~+60 (>45°C derating)
	Ingress protection	IP20	IP20
	Operating altitude range [m]	3000	3000

	Maximum efficiency	98.5%	98.5%
	HV / LV start function	Integrated	Integrated
	Size (W*D*H) [mm]	436*550*130	436*550*130
	Weight [kg]	25	28

3. 7 Fire Suppression system

The battery cabinet of BESS is equipped with a fire suppression system. In the event of a fire hazard inside the battery cabinet, the firefighting system will start and extinguish the fire. It includes solenoid valve, fire extinguishing pipe and smoke detector.

	Note:
	It is forbidden to use the BESS when the smoke detector is alarming, or the battery temperature is too high.

Fig. 3-5 Fire Protection System Fire Extinguishing Hose

The Solenoid valve is arranged on the fire extinguishing pipe.

Fire extinguishing pipe Location: On the battery cabinet door

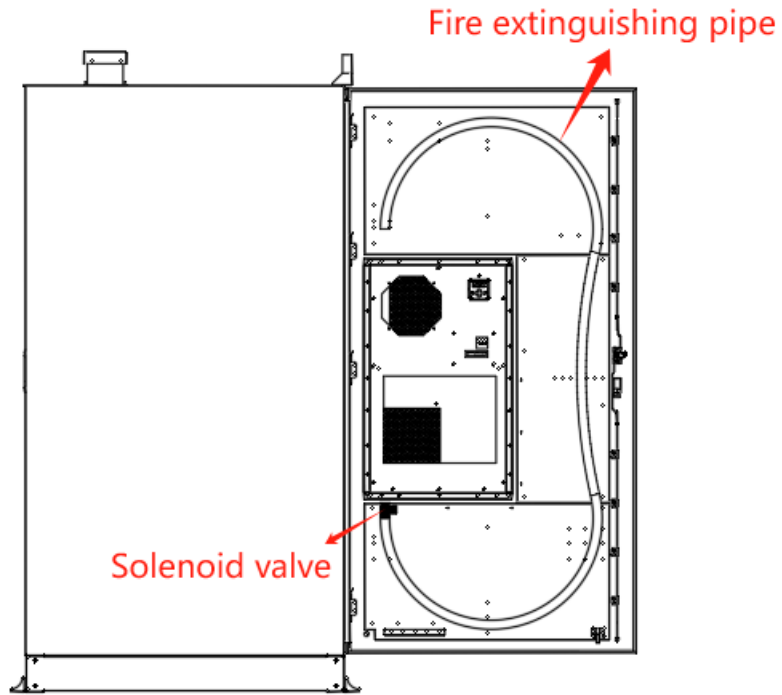

Fig. 3-6 Fire extinguishing pipe location



Fig. 3-72 Smoke Sensor

Smoke Sensor Location: Top of the battery cabinet

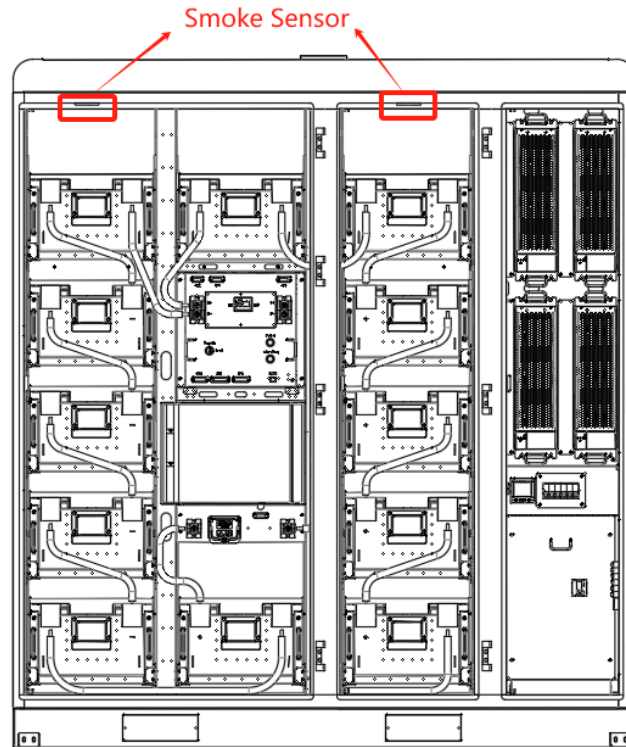

Fig. 3-83 Smoke Sensor location

The operating modes of the smoke sensor are as follows:

Item	Working status	Description	Remark
1	Monitoring status	The red indicator flashes approximately every 6 seconds	
2	Alarm status	The red indicator is always on	
3	Fault status	The red indicator flashes 2 times continuously about every 6 seconds	

Working principle of the firefighting system:

Item	Trigger component	Description
1	Fire extinguishing pipe	When the surface of the fire extinguishing pipe meets a fire, it will burst into a natural discharge outlet to release the fire extinguishing agent, to achieve the effect of fire suppression.
2	Solenoid valve	<p>A set of detection circuit is installed in the battery cabinet, and the detection circuit includes two smoke detectors:</p> <ul style="list-style-type: none"> ➢ BESS will now stop running when only one smoke detector is activated. ➢ When both smoke detectors are activated together, the

		BESS system will immediately stop running, and the solenoid valve will be activated to release the extinguishing agent, thus achieving the effect of suppressing the fire.
--	--	--

3.8 Air conditioning system

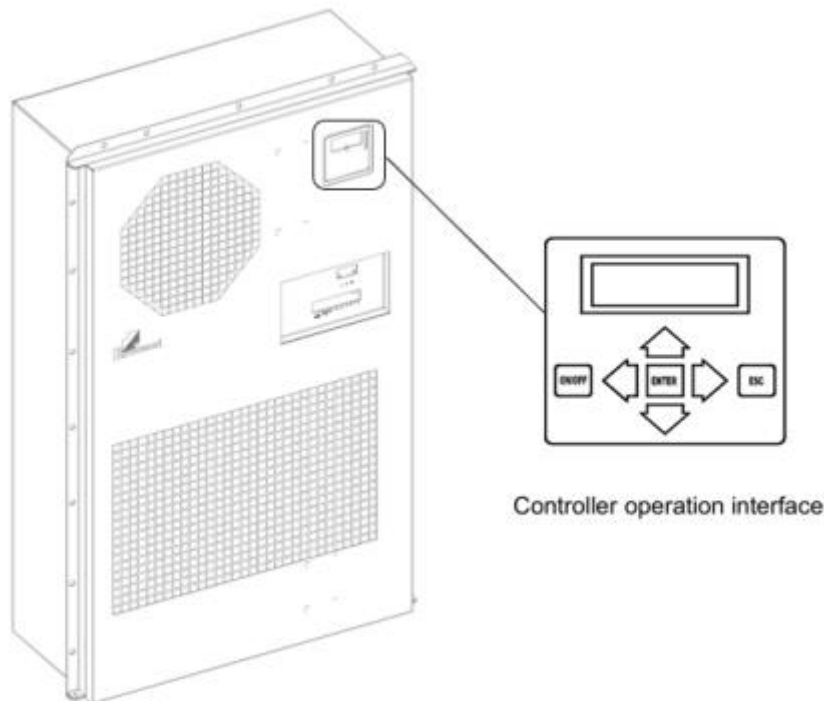

Fig. 3-9 Air conditioner operation interface

parameter		EC30HDN
Model		C1C
Overall dimensions, quality and installation method		
Overall dimensions (high x width x deep)	mm	746×446×300
Dimensions with flange (height x width x deep)	mm	783×483×300
Quality	kg	48
Way to install		Door outfit

Application environment		Outdoors
Environmental protection		
Scope of working environment	°C	-40 to +55
Noise level (Indoor side)	dB(A)	65
IP levels of protection		IP 55
Cryogen		R134a
Whether the RoHS 2 is satisfied		Yes
Refrigeration / Heating capacity		
Refrigeration capacity is L35	W	3000
Add heat (optional)	W	1000
Consumed power		
Refrigeration input power is L35	W	1240
Refrigeration input current is L35	A	5.7
Blowing rate		
Internal circulation air volume	m ³ /h	850
Maximum running current	A	9.8
Power system		
Power supply range	V, Hz	220±15%, 50/60
Rated operating voltage - the controller	V, Hz	220, 50/60
Rated operating voltage - Refrigeration / heating system	V, Hz	220, 50/60

●

4 Installation

The installation process for BESS is as follows:

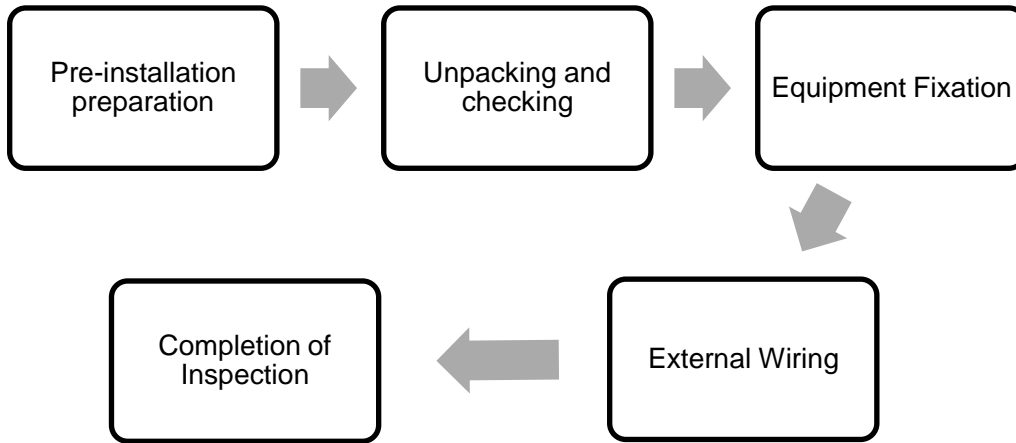

Fig. 4-1 Installation process







4. 1 Installation Preparation





4. 1. 1 Installation Tools

Note:

- The tool pictures are for reference only.
- The tool tables may not list out some tools required onsite. Onsite installation personnel and the customer need to prepare the tools based on the site requirements.

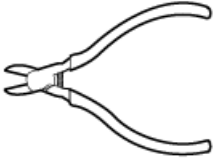
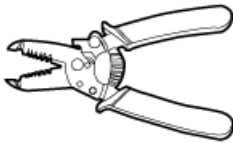
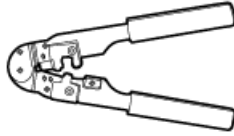
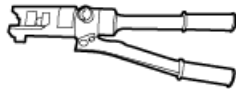
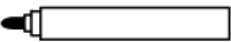
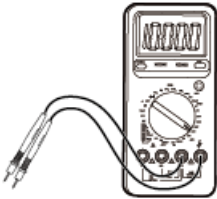
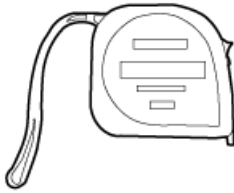
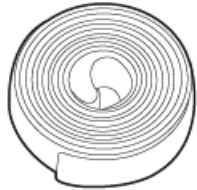
(1) Tool list

 	 	 	
Phillips Insulated	Insulated torque	Insulated torque	Rubber mallet

Torque Screwdriver	socket wrenches(M12、M8)	screwdriver	
			
Tweezers	Wire stripper	Crystal Crimping Pliers	Hydraulic press
			
Permanent Marker	Multimeter	Tape rule	Heat shrink tubing
			
Hot air gun	Cable ties	Forklift truck	Hand Forklift

(2) Key equipment and tool for installation:

Number	Recommended tools	Quantity	Use
1	Forklifts	1 unit	Rated load $\geq 3.5T$. For unloading and handling
2	Drill and M12 tip	1 group	Drilling in the ground. Place the expansion screws (M12*150)
3	Hammer	1Piece	Knock the expansion bolt into the fixed position
4	Sleeve tool	1 group	M12 sleeve: For tightening expansion bolts M8 sleeve: Terminal block fixed

5	Insulated torque wrench	1 Piece	Check and mark the torque value
6	Adjustable wrench	1 Piece	Tighten the bolts to which the cable is connected
7	Diagonal jaws	1 Piece	Cut off the nylon tie from the bag
8	Slotted screwdriver/crowbar	1 Piece	Unpacking operation

(3) Personal Protective Equipment (PPE) :

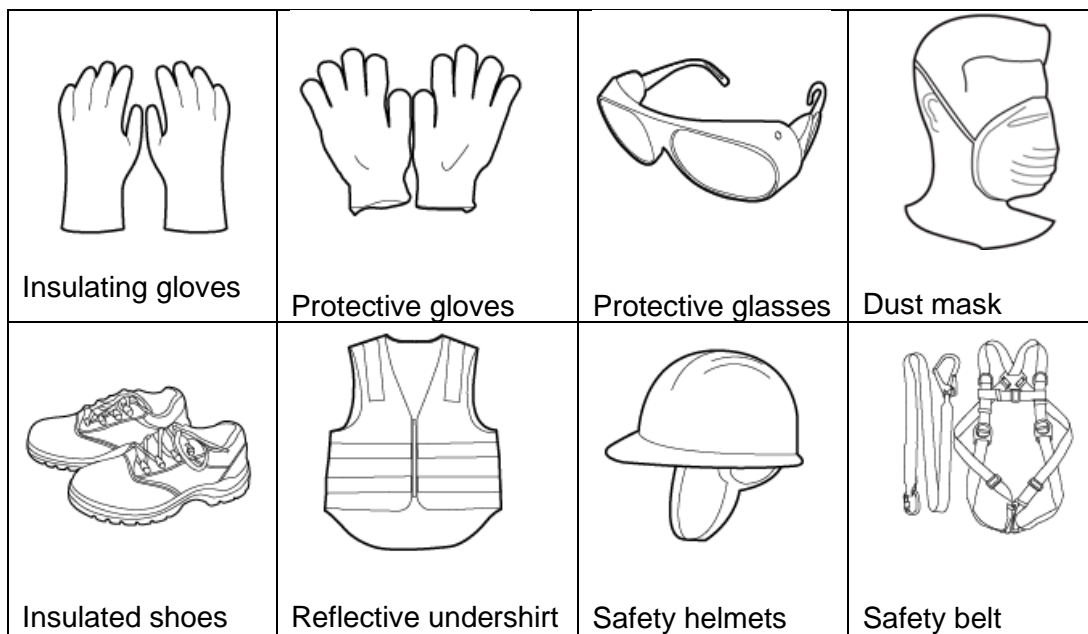

Fig. 4-1 Protection equipment

4. 1. 2 Installation site environmental requirements

Notice:

Refer to the NFPA 855 Standard for the Installation of Stationary Energy Storage

Systems and local laws and regulations.

General requirements:

- The horizontal level of the installation site shall be above the highest water level of that area

in history and at least 300 mm above the ground. The site must not be located in a low-lying land.

- The ESS and the site must be in an environment free from explosion risks.
- Transportation to the site shall be convenient and fire suppression facilities shall be reliable.

NOTE

- When installing, commissioning, and operating the ESS, ensure that at least two
- gas fire extinguishers, such as heptaffluoropropane, perfluorohexanone, or carbon
- dioxide fire extinguishers, are provided near each unit to ensure fire safety.
- Reserve sockets for the water fire suppression system at the ESS site.
- The site shall be in a well-ventilated place.

Do not select the sites that are not recommended by industry standards and regulations, including but not limited to the following areas:

- Areas with sources of strong vibration, loud noises, and strong electromagnetic interference
- Areas with dust, oil fumes, harmful gases, corrosive gases, etc.
- Areas with corrosive, flammable, and explosive materials
- Areas with adverse geological conditions such as rubbery soil and soft soil layer, or prone to waterlogging and land subsidence Under a reservoir, water landscape, and water room

NOTE

- If areas prone to waterlogging cannot be avoided, install water blocking and drainage facilities or raise the ground.

- Cable trenches shall not be used for drainage. Fire retardant sealing shall be implemented at cable holes (such as holes through partition walls and floors).
- Areas prone to earthquakes and with seismic fortification intensity higher than 9.
- Areas prone to debris flow, landslide, quicksand, karst caves, and other direct hazards
- Areas within the mining land subsidence (dislocation) zone.
- Areas within the scope of blasting hazard
- Areas prone to flood due to a dam or level failure Protection areas for important water supply sources
- Protection areas for historic relics Populated areas, high-rise buildings, and underground buildings Intersections and busy roads of urban main roads

Requirements for flood and waterlogging prevention in site selection:

- The site design elevation of a medium- or small-scale electrochemical energy storage system shall be higher than the flood level with a probability of 2% or the historical highest waterlogging level.
- If the site design elevation cannot meet the preceding requirements, change the site location or take different flood and waterlogging prevention measures based on the site requirements.
- For energy storage plants prone to wind and waves from rivers, lakes, and seas, the elevation of flood prevention facilities shall consider the wind and wave height with a probability of 2% and an additional safety height of 0.5m.
- When a large amount of catchment water flows into or passes through the site, it is recommended that side ditches or drainage ditches be built to drain water from the ground in an organized manner.

4. 1. 3 Outdoor installation requirements

The general requirements for selecting an outdoor ESS site are as follows:

- There must be no vegetation, especially flammable plants within 3 m of the ESS or the site to protect the ESS from possible fires. (Exemption: Single specimens of trees, shrubbery, or cultivated ground cover such as green grass, ivy, succulents, or similar plants used as ground covers shall be permitted to be exempt provided that they do not form a means of readily transmitting fire.)
- No obstacle shall be above the ESS. For example, the ESS must not be installed under a parking shed and PV modules must not be installed on the top of the ESS.
- The safety distances between the ESS and buildings shall comply with local fire protection regulations or standards.
 - The ESS located outdoors must be at least 10 ft (3.048 m) away from lot lines, public ways, buildings, combustible materials, hazardous materials, high-piled stock, parking spaces, and other exposure hazards not associated with electrical grid infrastructure.
 - If either of the following conditions is met, the distance between the ESS and the production building shall be permitted to be reduced to 3 ft (0.914 m). In addition, clearance requirements for equipment transportation, installation, and maintenance shall be considered.
- There are 1-hour freestanding fire walls, extending 5 ft (1.5 m) above and extending 5 ft (1.5 m) beyond the physical boundary of the ESS installation.
- Non-combustible exterior walls with no openings or combustible overhangs are provided on the walls adjacent to the ESS and the fire resistance rating of the exterior walls complies with 2-hour fire resistance rating of ASTM E119 or UL 263.
 - The distance between the exhaust device of an ESS and the heating and ventilation vents, air intake vents of air conditioners, windows, doors, unloading platforms, and fire sources of other buildings or facilities must be greater than 4.6 m.
- The ESS cannot be installed in salt-affected or polluted areas because this will cause corrosion. The ESS can be used in the following or better environments:

- Outdoor environment more than 2000 m away from the coast. You are advised not to use the ESS in an area 500 m to 2000 m away from the coast. (If your location is similar like this description, please confirm with the vendor or the Dunext Company's engineers.) If the site is less than 500 m away from the coast, outdoor deployment is not allowed. Install the ESS indoors according to Indoor Requirements.

- More than 1500–3000 m away from heavy pollution sources such as smelteries, coal mines, and thermal power plants

- More than 1000–2000 m away from medium pollution sources such as chemical, rubber, and electroplating industries

- More than 500–1000 m away from light pollution sources such as packing houses, tanneries, boiler rooms, slaughterhouses, landfill sites, and sewage treatment plants

Security fencing:

It is recommended that physical walls or fences be used for isolation and protection in the energy storage equipment area. The fences shall be equipped with a door lock and the recommended fence height is greater than 2.2 m. Fire walls shall be permitted to be substituted for part or all of the fences, depending on the actual design plans.

4. 1. 4 Indoor Requirements

The fire safety of the ESS dedicated-use buildings or structures must comply with local laws and regulations. Refer to standards including but not limited to NFPA855 and comply with the following requirements:

- An ESS dedicated-use building or structure is required, with a 2-hour fire resistance rating for the walls and a maximum of 600 kWh lithium batteries stored per fire protection unit. The building or structure shall meet relevant requirements.

- The building or structure shall only be used for the operation of the ESS equipment.
- Occupants in the rooms and areas containing the ESS shall be limited to personnel that operate, maintain, service, test, and repair the ESS and other energy systems.
- No other occupancy types shall be permitted in the building or structure.

- The distance between the ESS dedicated-use building or structure and the following places shall be greater than or equal to 3.0 m: lot lines, stored combustible materials, hazardous materials, high-piled stock, electrical infrastructure, public ways, buildings, and parking spaces.

- The layout in the ESS dedicated-use building or structure shall comply with local fire protection laws, regulations, and standards, such as the safe distance and layout of buildings and materials in various production scenarios.

- Combustible materials shall not be stored in the ESS dedicated-use building or structure. The distance between the combustible materials and the building or structure shall be greater than or equal to 3 m.

- The ESS dedicated-use building or structure shall be equipped with fire extinguishers filled with halogenatedane, heptaffuoropropane, perffluorohexanone, carbon dioxide, or dry powder. Each fire protection unit shall be equipped with at least two fire extinguishers, which shall be checked and replaced periodically.

- The ESS dedicated-use building or structure shall be configured with room level smoke detectors. At least two detectors of each type shall be configured, and the automatic fire alarm system shall be enabled.

- The ESS dedicated-use building or structure shall be equipped with independent ventilation devices. The ventilation devices shall interact with the fire alarm system and limit the concentration of flammable gas to below 25% of the lower flammability limit (LFL).

- The ESS dedicated-use building or structure shall be equipped with room-level flammable gas detection devices. Rooms containing the ESS shall be protected by an approved continuous gas detection system that complies with the following:

The gas detection system shall be designed to activate the mechanical exhaust ventilation system when the level of flammable gas detected in the rooms exceeds 25% of the LFL.

- The mechanical exhaust ventilation system shall remain on until the flammable gas detected is less than 25% of the LFL.

- The gas detection system shall be provided with a minimum of 2 hours of standby power.

- Failure of the gas detection system shall annunciate a trouble signal at the monitoring center.

- The ESS dedicated-use building or structure shall be equipped with fire suppression facilities such as water spray or sprinkler systems. The water stored shall be able to supply for more than 2 hours at the designed water flow rate and the surrounding water source shall be able to supply water continuously for 12 hours to cope with the risk of reignition or fire spreading after a battery fire is extinguished. The water spray or sprinkler systems shall be designed using a minimum density of 0.3 gpm/ft² (12.2 mm/min) based over the area of the room or 2500 ft² (230 m²) design area, whichever is smaller.

- The ESS dedicated-use building or structure shall be equipped with pressure relief explosion-proof devices or pressure relief channels (such as glass windows and magnetic lock doors) with equivalent areas. According to the NFPA 68 standard, if side pressure relief is adopted, a protective fence or wall shall be installed outside the pressure relief channels, and the fence or wall shall be at least 3 m away from the pressure relief wall.

- The ambient temperature inside the building where the ESS is located shall be lower than 55°C when the ESS is running.

- The indoor ceiling height of the building or structure shall be at least 4.5 m. A minimum of 2 m clearance above the ESS shall be reserved for pressure relief and no flammable materials shall be placed above the ESS.

- Maintenance clearances:

- The entrance and exit doors shall meet the clearance requirements for installing the ESS using a forklift.

- The indoor area of the building shall meet the clearance requirements for the ESS maintenance and forklift operations.

- Exits and aisles:

- Safety exits and aisles shall be set for all areas containing the ESS in accordance with the local building code.

- Emergency lighting shall be provided for all exit doors and aisles in accordance with the local building code.

- All exit doors shall be opened toward the exit direction.

- Exemption conditions:

- The preceding installation requirements shall be in line with the requirements approved by the local fire department. On the premise that the fire department approval is obtained, the requirements on water sprinkler systems, smoke detection, flammable gas detection, and explosion-proof can be exempt. However, the requirements on mechanical exhaust ventilation, pressure relief clearance above the ESS, heat dissipation, and maintenance clearance shall be met.

When approved by the fire department, the fire control and suppression systems, size and separation requirements, and the water supply shall be permitted to be omitted in ESS dedicated-use buildings located more than 100 ft (30.5 m) from buildings, lot lines that can be built upon, public ways, stored combustible materials, hazardous materials, high piled stock, and other exposure hazards not associated with electrical grid infrastructure.

- Requirements for offshore indoor applications:

- If the ESS is less than 500 m away from the coast, ensure that it is located in an indoor environment within a dedicated protective building that has controllable temperature and humidity using air conditioners.

The indoor environment must meet the C4 or higher level specified in ISO 12944/ISO 9223. In addition, the preceding site selection requirements for indoor applications must be met.

- Anti-salt fog measures must be taken for outdoor air conditioners and mechanical ventilation

devices. Anti-salt fog filters must be installed at the air intake and exhaust vents, or anti-salt fog air conditioners or ventilation devices must be used. The filters must be maintained and replaced periodically.

4. 1. 5 Clearance Requirements

The following figure shows the minimum clearance requirements for installation and O&M. The equipment clearances must also meet the site selection requirements.

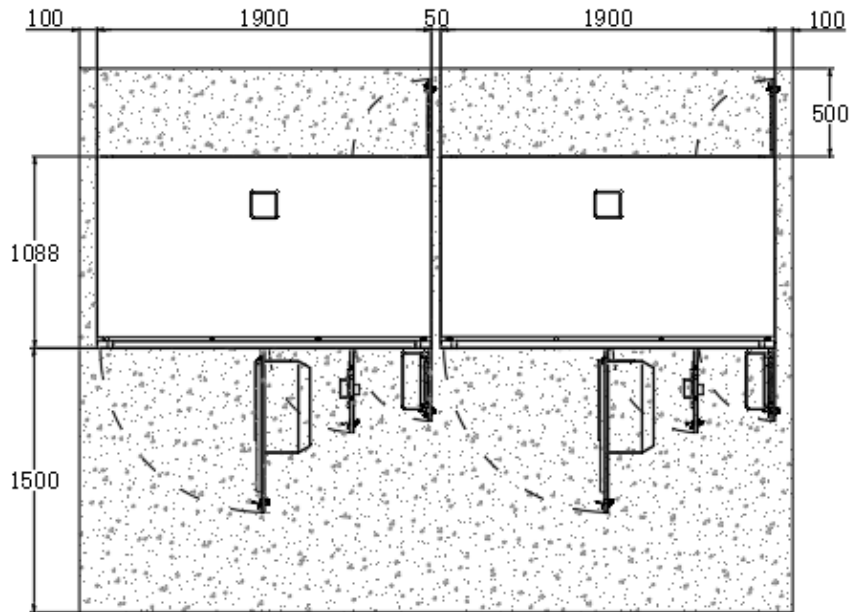

Fig. 4-1-5 Single PowerHill Layout Recommendation

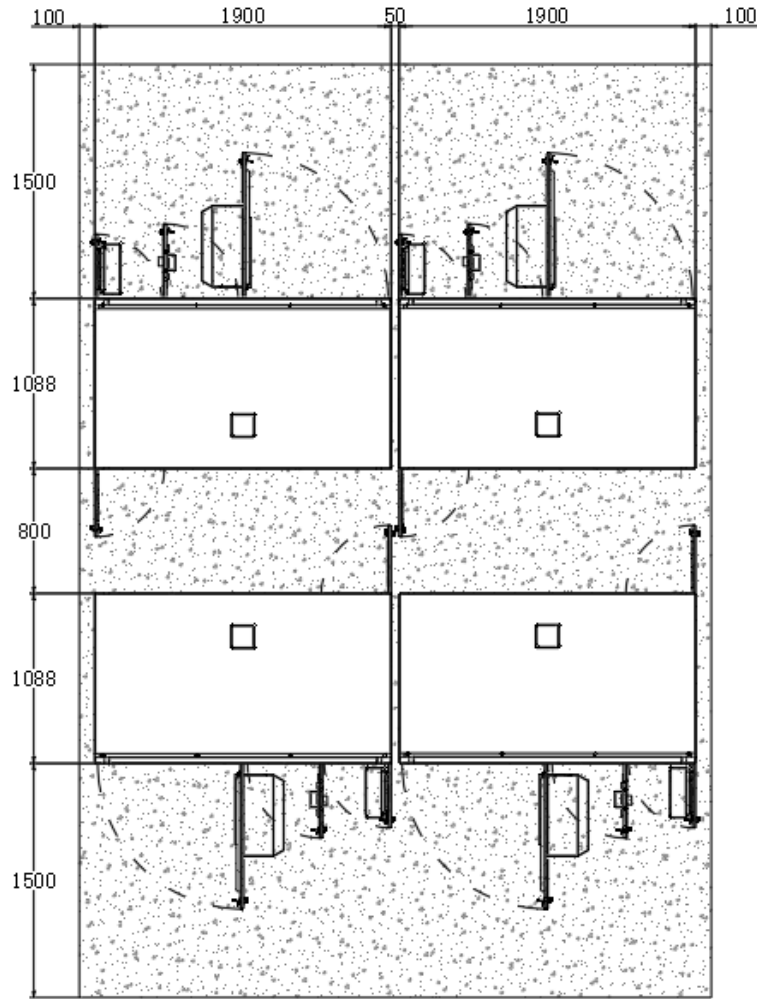

Fig. 4-1-5 Multi PowerHill Layout Recommendation

4. 1. 6 Foundation Requirement

Requirements for foundation design solution:

- The ESS must be installed on concrete or other non-combustible surfaces. Ensure that the installation surface is horizontal, secure, flat, and has sufficient load-bearing capacity. Subsidence or slope is not allowed.
- The foundation shall sustain the total weight of the equipment. If the loadbearing capacity of the foundation does not meet the requirement, a review is required.
- The bottom of the excavated foundation must be compacted and flat.
- After the foundation is excavated, prevent water from entering the foundation. If water enters the foundation, excavate and refill the affected parts.

- The foundation must be above the highest water level of the local area in history and at least 300 mm above the ground.
- Construct drainage facilities based on the local geological conditions and municipal drainage requirements to ensure that no water will accumulate at the equipment foundation. The foundation construction must meet the local drainage requirements for the maximum historical rainfall.
- The reserved holes on the foundation and the cable inlets at the bottom of the equipment shall be sealed.
- The foundation drawings shall not be used as the final construction drawings and are for reference only. For details, contact the product manager of the Dunext Company or EPC company to obtain the foundation drawings. The design specifications of the ESS foundation shall be reviewed based on the installation environment, ground bearing capacity, geological features, and seismic resistant requirements of the project site.

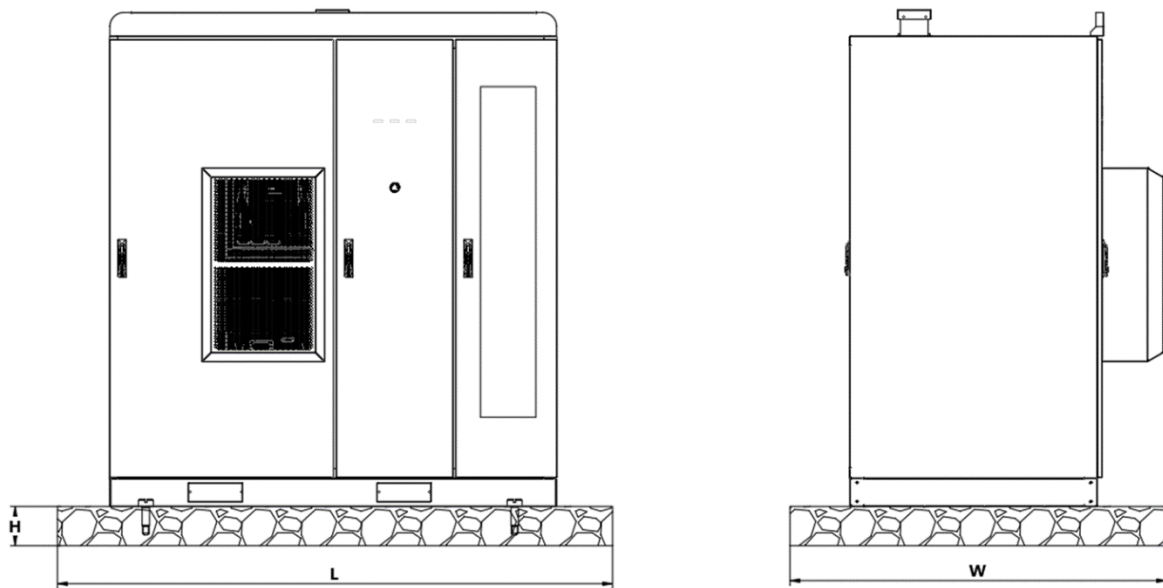



Fig. 4-1-6 Site Installation Foundation

Installation foundation requirements		
No.	Category	Parameter
1	Minimum hardened area	$L \geq 2000\text{mm}$, $W \geq 1200\text{mm}$
2	The height of the installation foundation	$H \geq 100\text{ mm}$ (suggesting the foundation surface is higher than the historically high flood level)
3	Mounting foundation load carrying capacity	Bearing capacity $> 2.5\text{ t / m}^2$
4	Foundation service life	$\geq 20\text{ years}$

5	Foundation level	3mm /m ²
---	------------------	---------------------

4. 1. 7 Forklift Requirements

During transportation, to ensure that the PowerHill products are in a better state of protection, please try to choose to transport them with packaging and follow the instructions of the various signs on the packaging, which are shown in the table:

	<p>Danger:</p> <ul style="list-style-type: none"> ◆ During transportation, the surrounding sites must be inspected, and an obvious safety cordon must be set up for safety protection. ◆ During transportation, any irrelevant persons are not allowed to enter the transportation danger zone.
---	--

	<p>Warning:</p> <ul style="list-style-type: none"> ◆ When transporting the outdoor energy storage cabinet, only forklifts can be used. ◆ Do not insert the fork from where the air conditioner is located. ◆ When handling this product, please use an electric forklift with movable forks. A manual forklift is not recommended. ◆ Protection should be provided to avoid damage to the surface of the equipment when handling with a forklift.
--	--

- Do not move the ESS after battery packs are installed.
- If a forklift is used to install the ESS cabinet, ensure that the forklift has a load-bearing capacity of at least 2 t.
- If a forklift is used to install and maintain battery packs, ensure that the forklift has a load-bearing capacity of at least 1 t.
- It is recommended that the length of the tynes be 1200 – 1500 mm, the width be 80–160 mm, and the thickness be 25–80 mm.
- Lifting height of a forklift: If the foundation is less than or equal to 0.3 m high, the lifting height shall be greater than or equal to 2 m. If the foundation is greater than 0.3 m high, the lifting height shall be increased accordingly.

For short distances, it is recommended that a forklift be used to transport the entire cabinet if it has not been removed from the shipping carton. Refer to the following table for forklift selection, Forklift Requirement 1 and Forklift Requirement 2, whichever one of these two requirements are met:

Forklift Requirements for PowerHill installation: 1	
Forklift specifications	PowerHill product is about 2.5 tons and that the forklift has a load-bearing capacity of at least ≥3.5 tons. If a forklift is used to install and maintain battery packs, ensure that the forklift has a load-bearing capacity of at least 1 t.
Fork length	The width of the outdoor energy storage cabinet is about 1.1 m, it is recommended to take length of the tynes at least > 1.1 m, the width be 80–160 mm, and the thickness be 25–80 mm.
Lifting height of a forklift	If the foundation is less than or equal to 0.3 m high, the lifting height shall be greater than or equal to 2 m. If the foundation is greater than 0.3 m high, the lifting height shall be increased accordingly.

Transportation methods are divided into two main forms depending on the direction of transportation: front insertion and side insertion.

Transportation scheme 1: Front insertion

1. Confirm forklift fork

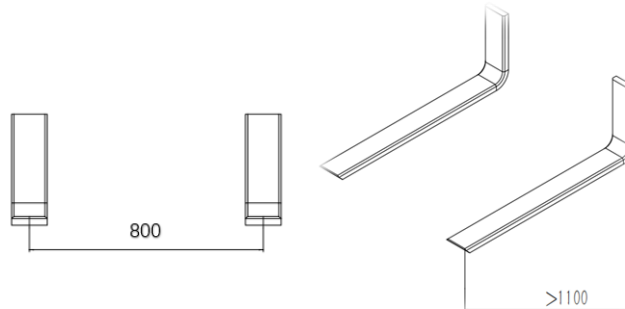

Fig. 4-2 Forklift Schematic1 | Transportation Option 1 Front Insertion

2. Remove the fork hole cover and confirm the fork hole

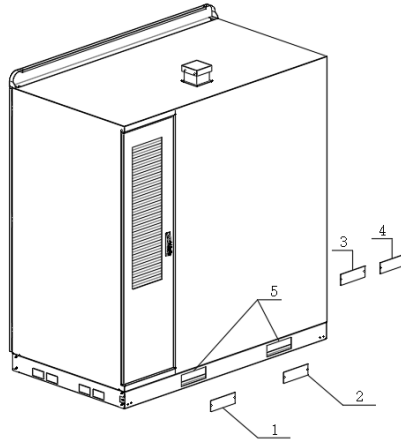

Fig. 4-3 Front Jack Location Diagram

Number	Name
1, 2, 3, 4	Forklift hole baffle
5	Forklift hole

3. Fork entrance

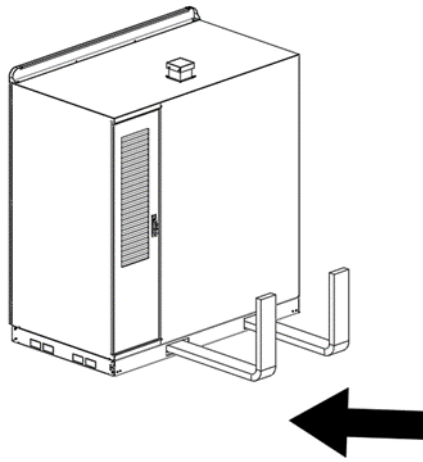

Fig. 4-4 Frontal Fork Transportation Direction

4. Transportation

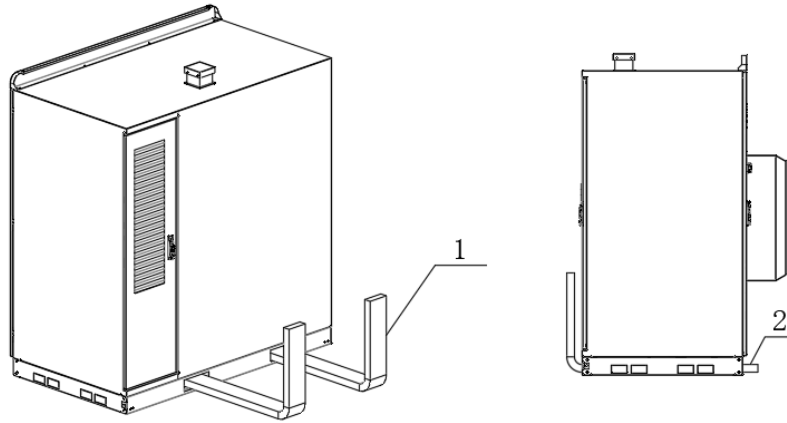

Fig. 4-5 Frontal Fork Transportation Orientation Diagram

Number	Request
1	The forklift should be forked in from the side away from the air conditioner, so that the distance between the fork and the rear side of the cabinet is < 50mm
2	To extend at least 50mm

Hoisting Requirements

- Before hoisting, ensure that the crane and hoisting ropes meet the loadbearing requirements.
- When installing or removing the hoisting equipment, do not drag it on the cabinet to prevent scratches.
- Do not hoist or move the ESS after battery packs are installed.

Stage	Precautions
Before hoisting	Crane hoisting capacity ≥ 2 t, working radius ≥ 2 m. If the onsite environment does not meet the required working conditions, ask a professional to assess the conditions.
	Only trained and qualified personnel are allowed to perform hoisting operations.
	Check that hoisting tools are complete and in good condition.
	Ensure that the hoisting tools are secured to a load-bearing object or wall.
	When the equipment is used outdoors, it is recommended that you hoist the equipment when the weather is good and there is no wind.
	Ensure that the crane and steel ropes meet the requirements before the hoisting.
	All doors of the equipment are closed and locked.
	Ensure that the steel hoisting ropes are securely connected.
During hoisting	Do not allow any unauthorized person to enter the hoisting areas and do not stand under the crane arm.
	Ensure that the crane is properly located and avoid long-distance hoisting.
	Keep the cabinet stable and horizontal during hoisting, and ensure that the diagonal gradient of the cabinet is less than or equal to 5 degrees.
	Ensure that the angle between two ropes is less than or equal to 90 degrees.
	Lift and land the cabinet slowly to prevent shock to equipment inside it.
	Remove the ropes after ensuring that the cabinet is placed evenly on the cabinet base.

Stage	Precautions
	Do not drag steel ropes or lifting appliances. Do not collide with the equipment.
	Secure the cabinet you have hoisted before hoisting another cabinet.

4. 2 Unpacking and Acceptance

4. 2. 1 Unpacking the PowerHill

NOTICE

To prevent the equipment from falling over, secure it to a pallet truck or forklift using ropes before moving it. Move the equipment with caution to avoid bumping or falling, which may damage the equipment.

- After placing the equipment in the installation position, unpack it with care to prevent scratches. Keep the equipment stable during unpacking.
- After unpacking, check whether the fastening components and removable components are loose. If they are loose, notify the carrier and manufacturer immediately.
- Before unpacking batteries, check whether the packaging is intact. Do not use batteries with damaged packaging. If any damage is found, notify the carrier and manufacturer immediately.
- If the installation environment is dusty, take dustproof and anti-condensation measures (for example, use a dust cover, plastic flim, or fabric cloth) after unpacking batteries to prevent condensation and dust buildup, which may corrode or damage the batteries.

After the PowerHill product is transported to the installation site, you are advised to remove the outer packing within 24 hours before installing the equipment.

- Remove the packing tape and foam from the outdoor energy storage cabinet;



Fig. 4-6 Outdoor Energy Storage Cabinet Packaging Illustration

- Remove the fixing bolts between the outdoor energy storage cabinet and on the wooden pallet

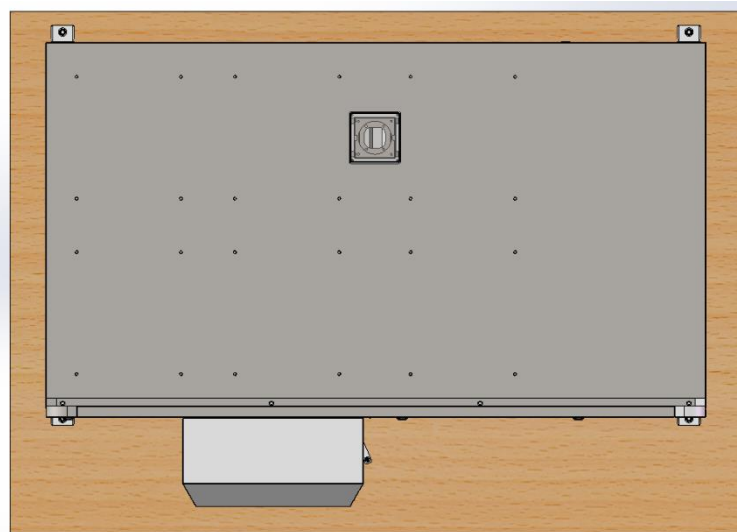

Fig. 4-7 Retaining 4 Bolts on the four corners

Note: Be careful and do not when removing the packaging of the outdoor energy storage cabinet.

4. 2. 2 Acceptance

Checking the Outer Packing

Before unpacking the PowerHill product, check the outer packing for damage, such as holes and cracks, and check the equipment model. If any damage is found or the equipment model is not what you requested, do not unpack the product and contact your dealer as soon as possible.

Checking Deliverables

After unpacking the equipment, check that the deliverables are intact and complete, and free from any obvious damage. If any item is missing or damaged, contact your dealer.

NOTE

For details about the number of accessories delivered with the equipment, see the Packing List in the packing case.

- Check the nameplate information and the model should match with the contract, such as: product model, rated capacity, voltage level, etc.
- Check whether there is deformation, paint loss, loose parts, etc. of the outdoor energy storage cabinet.
- Check whether the factory documents and accessories are complete, the delivery list of the outdoor energy storage cabinet is shown in the table:

Item	Material Name	Specification	Number	Remark
1	Cabinet	Fill in the model number when packing	1 PC	
2	30A DC Fused	HV110.PV30A	2 PCS	Equipped with MPPT only
3	16A AC Fused	RT28-32 16A	1 PC	
4	6A AC Fused	RT28-32 6A	1 PC	
5	2A AC Fused	RT28-32 2A	3PCS	
6	Factory Report	/	1 PC	
7	Key	K140	4 PCS	

4. 3 Installation

4. 3. 1 Installation Preparations

Preparing Tools

Before fixing the outdoor energy storage cabinet, please build the installation foundation in advance according to section 4.1.3.

- The following are the steps for fixing the equipment:

- (1) Select suitable tools to transport the energy storage cabinet to the installation site.
- (2) Prepare an impact drill and install an M12 drill bit.



Fig. 4-8Drill and M12 Drill Bit

- (3) Ground drilling: Align the impact drill with the center of the fixed mounting base holes, and drill holes to a depth of 120mm according to the following fixed hole positions (4 holes on both sides of the device);

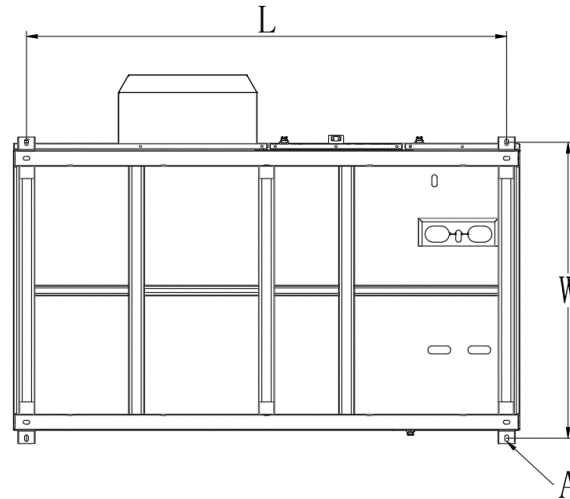

Fig. 4-9 Bottom Mounting Holes (Top View)

Product	L	W	A
PowerHill	1800mm	1110mm	4- \varnothing 14 \times 24

Bolt installation: After removing the hole slag, put the expansion bolts (4 pieces) into the corresponding holes, hammer to the bottom with a hammer, install the nut and gasket and tighten with sleeve, confirm the torque with a torque wrench (96 NM);



Fig. 4-10-3 Expansion Bolt Diagram

4. 4 Connection a ground cable for the ESS

NO TE

Ensure that the grounding impedance of the equipment complies with GB 50054 and local electrical standards

4. 5 Installing cables

Notes

	Danger:
	<ul style="list-style-type: none"> ◆ Wiring should be done by a qualified electrician. An electrician should confirm that all cables are properly connected. ◆ Wiring operations require at least two operators. One operator conducts wire operation, and the other operator monitors and reminds to avoid misoperation. ◆ Before wiring, make sure all switches are turned off. ◆ For any damage or accident caused by improper operation, the operator shall bear all the consequences arising therefrom.

	Danger:
	<ul style="list-style-type: none"> ◆ Before wiring, make sure all switches are turned off. ◆ Protective equipment must be worn when connecting. Must wear goggles, insulating gloves, and safety shoes.

4. 5. 1 Checking before cabling

The switch should be in off positions, Note the polarities when installing batteries. Do not connect the positive and negative poles of a battery or battery string together. Otherwise, the battery may be short-circuited.

- *Do not smoke or have an open flame around batteries.*
- *The site must be equipped with qualified firefighting facilities, such as fire sand and carbon dioxide fire extinguishers.*
- *Wear personal protective equipment and use dedicated insulated tools to avoid electric shocks or short circuits.*

Check the screws on copper bars or cables to the torque specified in this document. Periodically confirm whether the screws are tightened, check for rust, corrosion, or other foreign objects, and clean them up if any. Loose screw connections will result in excessive voltage drops and batteries may catch fire when the current is high.

When start to install cables, please make sure all switches off listed as below table.

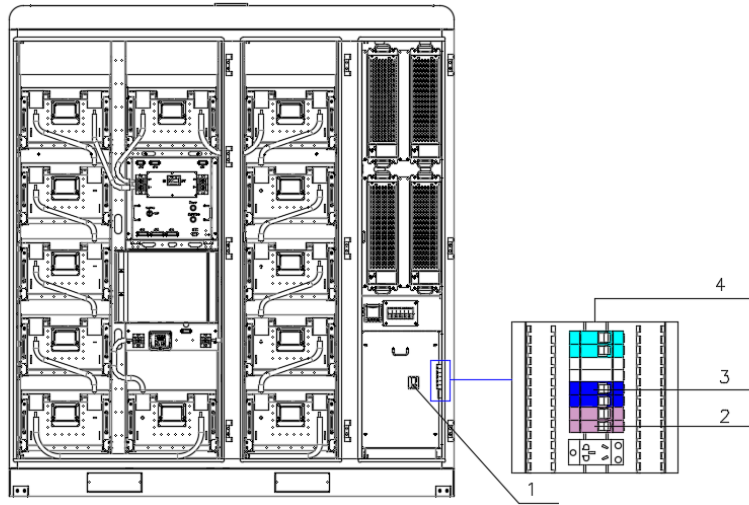

Fig. 4-5-1 BESS Front Switches

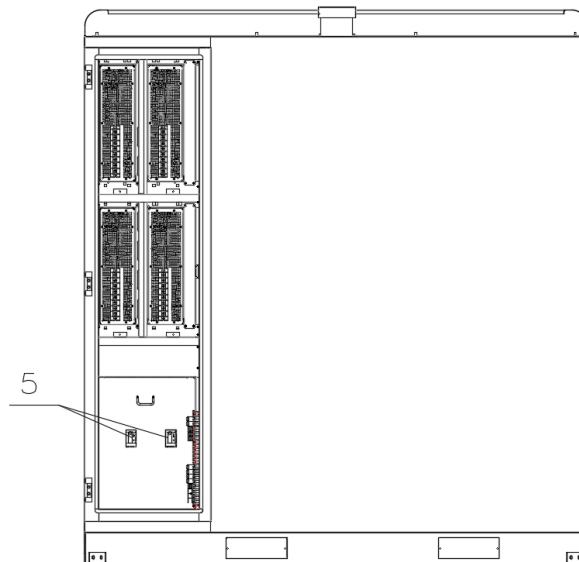

Fig. 4-5-2 BESS Back Side Switches

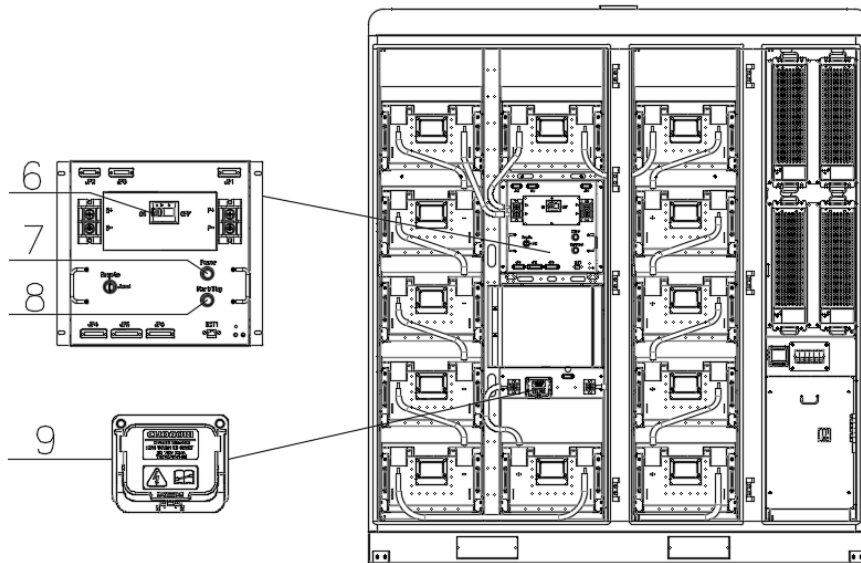

Fig. 4-11 Battery Cabinet Switches

All BESS switches must be in off state:

Number	Switch name and type	On/off judgment	Application
1	AC circuit breaker	OFF	AC circuit
2	Control power	OFF	Control board power supply
3	Air conditioner power supply circuit breaker	OFF	Air conditioner power supply
4	Secondary distribution circuit breaker	OFF	Auxiliary circuit
5	PV circuit breaker	OFF	Photovoltaic circuit
6	DC circuit breaker	OFF	DC circuit
7	Control box button switch	Recover	Control box power supply
8	Start-stop button switch	Recover	Start-stop signal
9	Manual service switch	Pull	DC segmentation switch

4. 5. 2 Install Grounding Cables

The grounding point of the ESS shell needs to be connected to the site ground network, and the interface is an M6 nut.

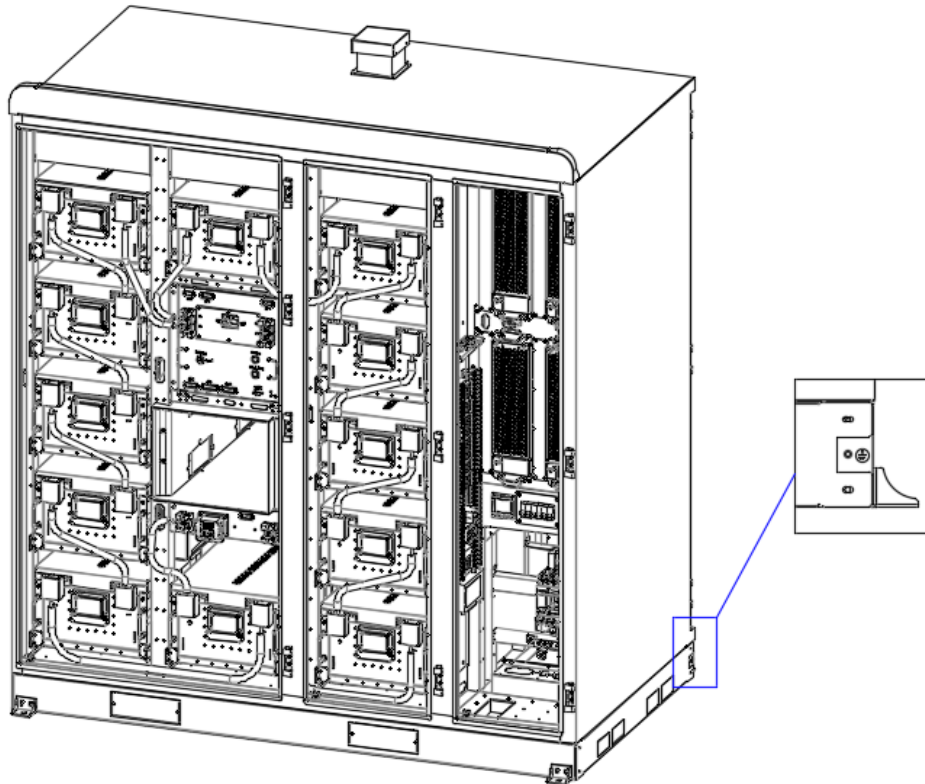

Fig. 4-12 Shell Ground Point Diagram

Main circuit conductor cross-sectional area S (mm ²)	External protective earth conductor S _p (mm ²)
S ≤ 16	S
16 < S ≤ 35	16
35 < S	S/2

4. 5. 3 Install AC Cables

Remove the bolts on all four edges of the baffle as shown below and remove the circuit breaker baffle.

※Reinstall the baffle after wiring is complete

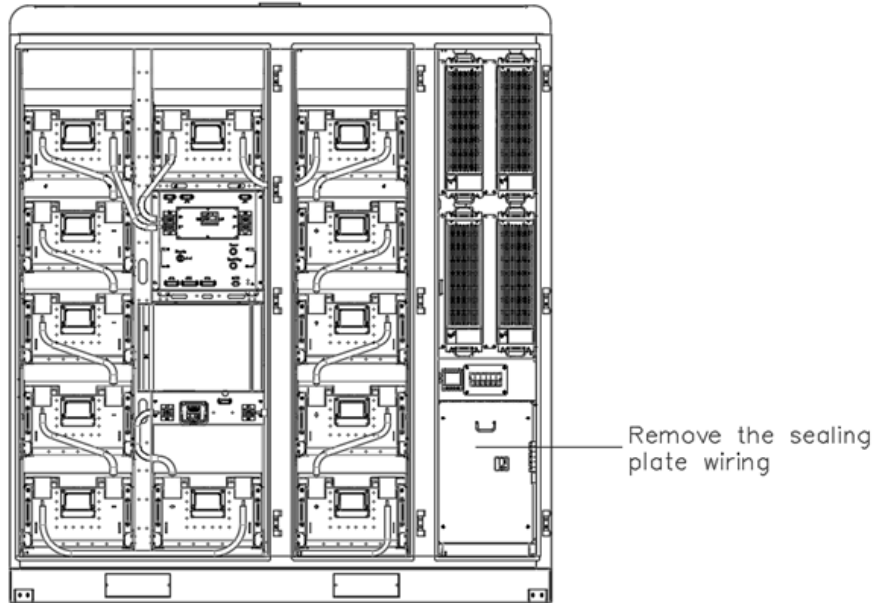

Fig. 4-5-213 Front Wiring Location

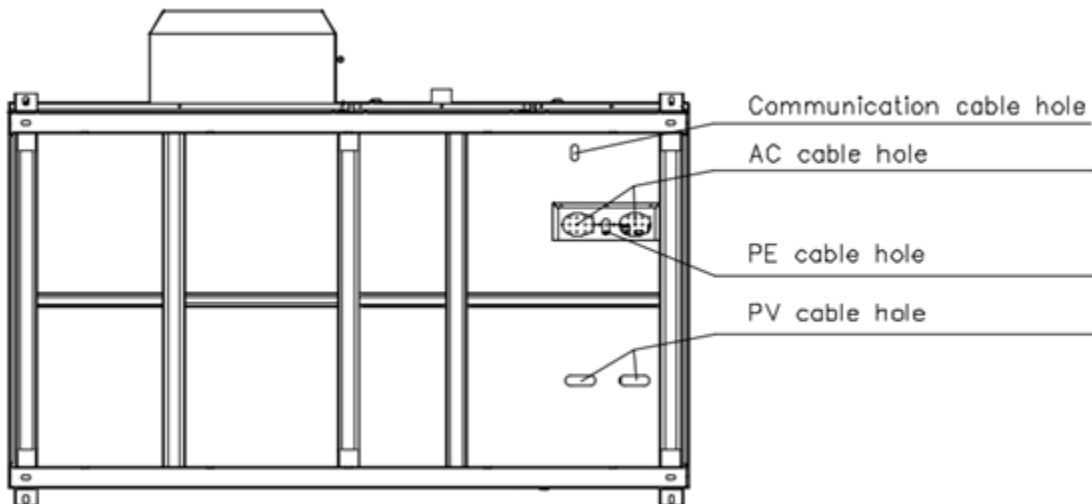

Fig. 4-5-3 Illustration of Bottom Wire Entry Hole

Insert the cables from the holes at the bottom of the cabinet, and connect and tighten them in the order shown in the figure below. The bolts are M 8 *1 6 bolt sets, the torque requirement

is 10 ± 1 N.M.

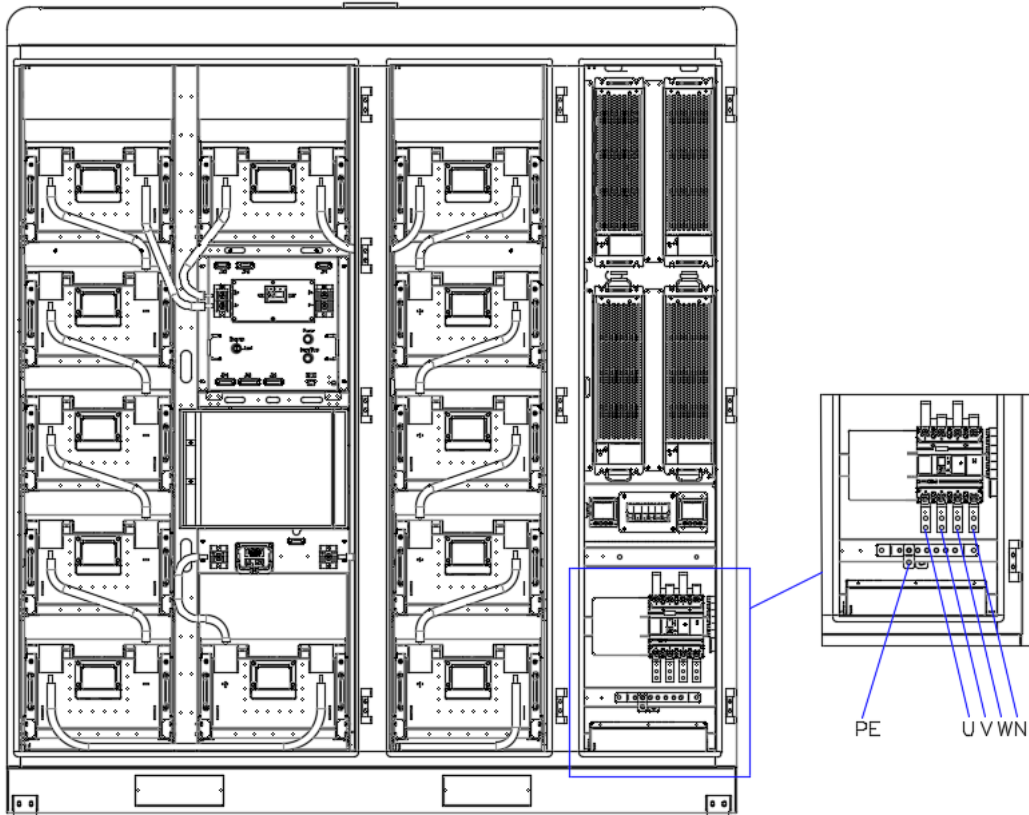

Fig. 4-14 Connecting AC cables

Product	Location	Terminals	Cable recommendation	Remark
PowerHill-P100	U	SC70-8	70mm ²	10±1N·m
	V	SC70-8	70 mm ²	10±1N·m
	W	SC70-8	70 mm ²	10±1N·m
	N	SC35-8	35 mm ²	10±1N·m
	PE	SC35-8	35 mm ²	10±1N·m
PowerHill-P60	U	SC50-8	50 mm ²	10±1N·m
	V	SC50-8	50 mm ²	10±1N·m
	W	SC50-8	50 mm ²	10±1N·m
	N	SC25-8	25 mm ²	10±1N·m
	PE	SC25-8	25 mm ²	10±1N·m

4. 5. 4 Installing Communication Cable

Use the network cable to connect to the network port shown in the following figure.

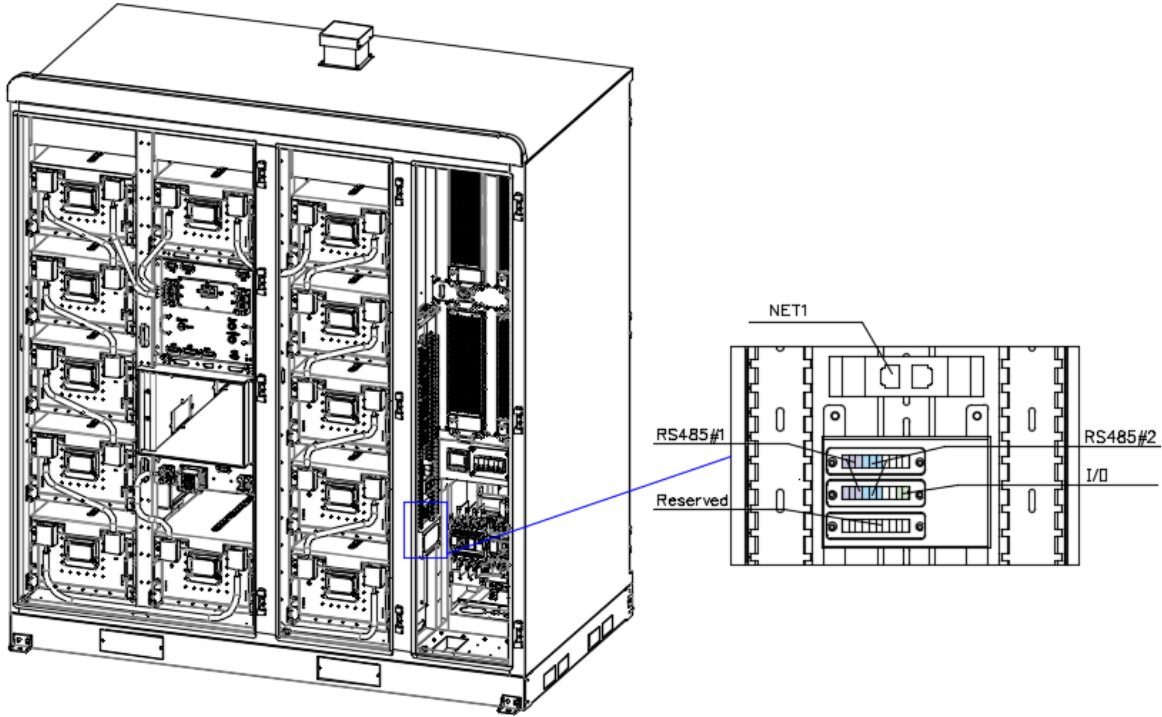

Fig. 4-15 Communication Cable Connection Interface

Location	Wiring terminal	Cable Recommendations	Remark
NET1	RJ45	Network cable	External Interface
RS485#1	E0510	Shielded twisted pair cable 2x0.5mm ²	UC External Interface
RS485#2	E0510	Shielded twisted pair 2x0.5mm ²	UC/ASS external interface
I/O	E0510	BVR-1mm ²	External emergency I/O interface

4. 5. 5 Installing PV Input Cables(Optional)

增加 PV 线缆安装的指导

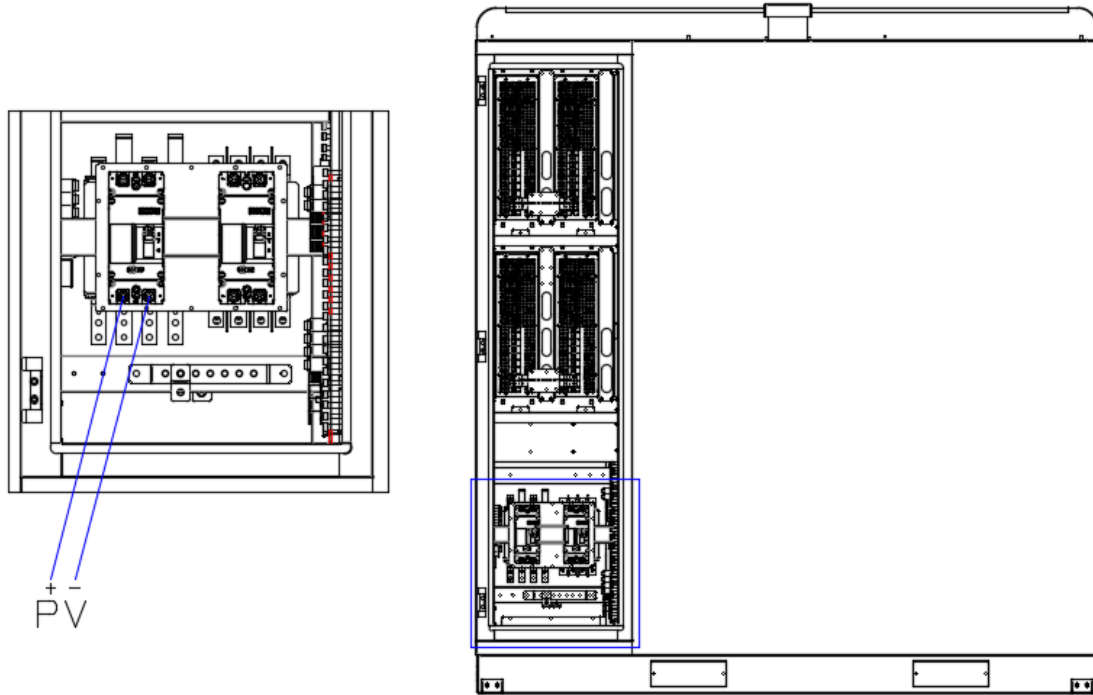

Fig. 4-16 Connecting PV cables

The system connection is 3P4W+PE, a TN-S system of neutral earthing systems.

Table 4-1 Grounding Conductor Cross Section Area Requirements

※The values in this table are valid only if the external protective earthing conductor is of the same metal as the main circuit conductor.

According to IEC 62109 7.3.6.3.4 External protective earthing conductor.

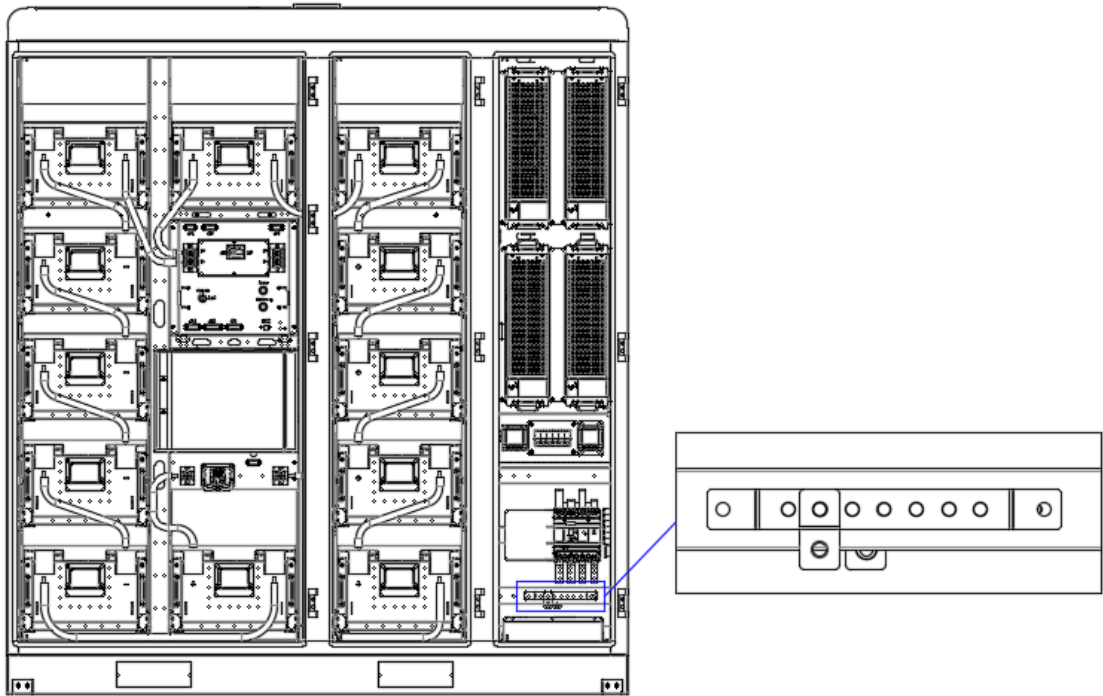



Fig. 4-17 Diagram of Internal Grounding Ground Array

- The system shell is likewise designed with a grounding connection point, and the BESS system in the power distribution system should be made to repeat the grounding, with a grounding impedance of $\leq 4 \Omega$.

Completion of Inspection

4. 6 Check After Installation

	<p>Warning:</p> <p>Another operator needs to check the wiring again to confirm that all cables are connected correctly</p>
---	---

Please make sure that all cables are connected in the designed position according to section 4.4.

Number	Location
1	Service switch
2	AC, load, PV wiring
3	Grounding cable routing
4	Communication cable routing

4. 6. 1 Bolt Torque Inspection

Make sure all bolts are tightened as required below. After confirming the torque, make a red mark on the bolt as a marker.

No.	Location	Screw	Torque
1	Grounding cable	M12*150	96±5 N·m
2	AC, load, PV cable	M 8 * 1 6	10 ± 1N·m
3	Grounding cable	M 8 * 1 6	10 ± 1N·m

5 Powering-On the PowerHill Product

5.1 Check Before Power-On

5.1.1 General check

Make sure to complete the wiring check in Section 4.5

Check whether the SPD micro-break is turned on and check whether the SPD is damaged.

Check that the intermediate service switch is turned on.

No.	Check items	Expected Result
1	Appearance	<ul style="list-style-type: none"> • The equipment is intact and free from rust or paint flake-off. If the paint flakes off, repair the damaged paint. • The labels on the device are clear. Damaged labels must be replaced
2	Cable appearance	<ul style="list-style-type: none"> • Cable sheathings are properly wrapped and not damaged. • Cable hoses are intact.
3	Cable connection	<ul style="list-style-type: none"> • Cables are connected in the designed positions. • Terminals are prepared as required and securely connected. • Labels on both ends of each cable are clear and specific, and attached in the same direction.
4	Cable routing	<ul style="list-style-type: none"> • Electrical and extra low voltage (ELV) cables are routed separately. • Cables are neat and tidy. • Cable tie joints are evenly cut without burrs. • Cables are placed properly and with slack at bending points to avoid stress. • Cables are routed neatly without twists or crossovers in the cabinets.
5	Battery pack copper bar	The copper bar is not deformed, and the plastic dip coating is not damaged

6	Switch in OFF state	<ul style="list-style-type: none"> • The DC LV Panel switch is set to OFF. • The battery rack switch is set to OFF.
7	Lighting arrest check	Lightning arrester micro-break is in "ON" state (marked in red).
8	Foundation check	The bottom of the energy storage cabinet is fixed and the support is stable and reliable
9	Ambient environment check	The temperature, humidity and ventilation of the environment where the PowerHill Product is located where is met the requirements as described in manual.
10	Work space check	Enough space around PowerHill product
11	No water or ice inside	No condensation or ice inside the cabinet
12	Check inside of Cabinet	No tools, parts, iron filings or other foreign objects left inside the cabinet.

5.2 Power On Process

	Danger:
	<ul style="list-style-type: none"> ◆ Make sure to complete the pre-power-on inspection before power on. ◆ Power-on operation requires at least two operators. One operator performs power-on operation, and the other operator monitors and reminds to avoid mis operation. ◆ For any damage or accident caused by improper operation, the operator shall bear all the consequences arising therefrom.

- AC and DC side power-on

➤ BESS main circuit on-grid/off-grid power-up process is into 3 steps:

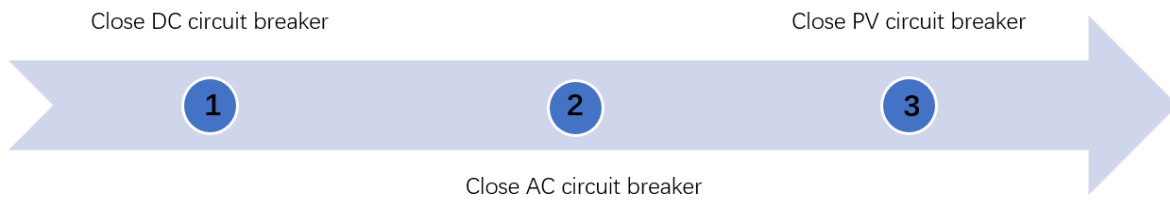

Fig. 5-1 BESS Main Circuit Power-Up Procedure

Procedure

- Step 1: turn on the DC switch in the control box.
- Step 2: turn on the AC switch in the distribution board.
- Step 3: turn on the PV switch (optional, if PV strings is connected)

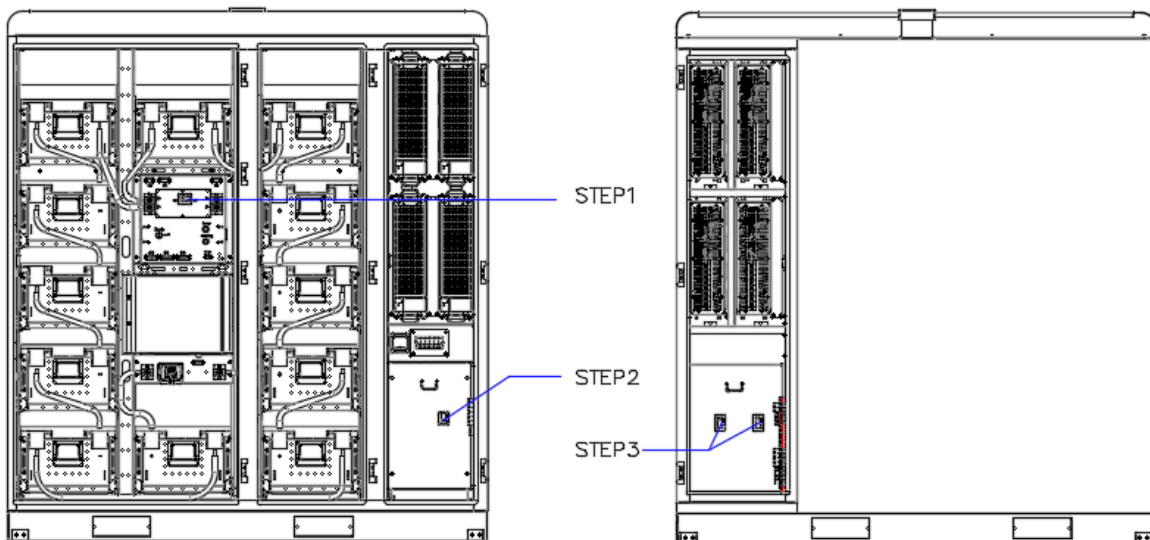

Fig. 5-2 Main Circuit Switch Position Diagram

- Secondary circuit power-on
- The secondary circuit on-grid power-on process is divided into 4 steps:

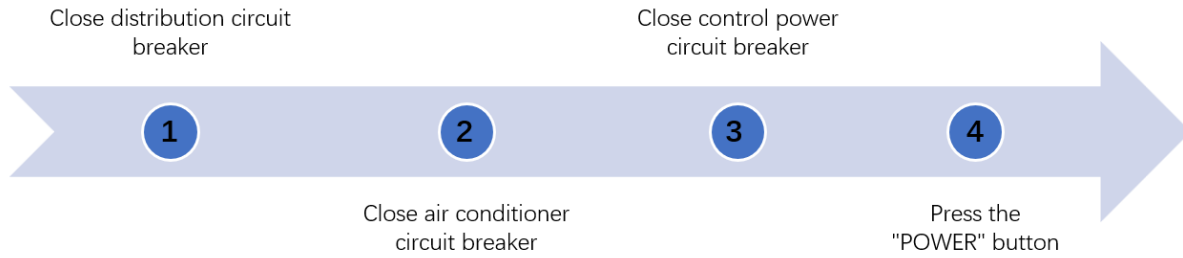

Fig. 5-3 BESS Secondary Power Supply On-Grid Power-Up Process Procedure

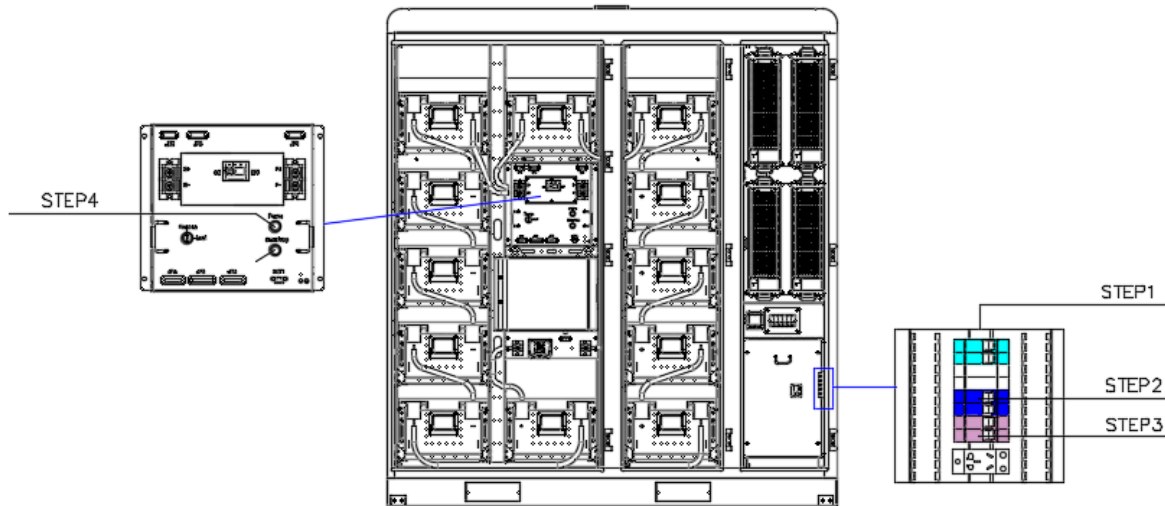

Fig. 5-4 Illustration of Secondary Circuit On-Grid Connection Switch Positions

After the steps are performed in sequence, the power grid is powered on, the AC circuit is started, check whether the indicator light of the BESS control box is on, and whether the screen of the control box is displayed. If the BESS status is normal, the running indicator is on, the fault indicator and the alarm indicator are off. Then enter standby mode, please wait for an external command to be received.

➤ The secondary circuit off-grid power-on process is divided into 5 steps:

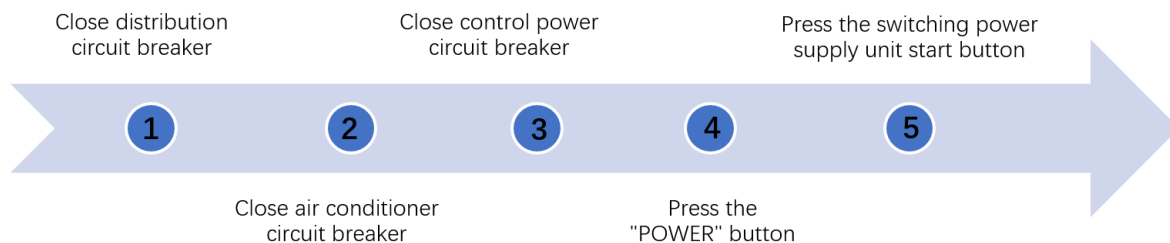

Fig. 5-5 BESS Secondary Power Supply Off-Grid Power-up Procedure

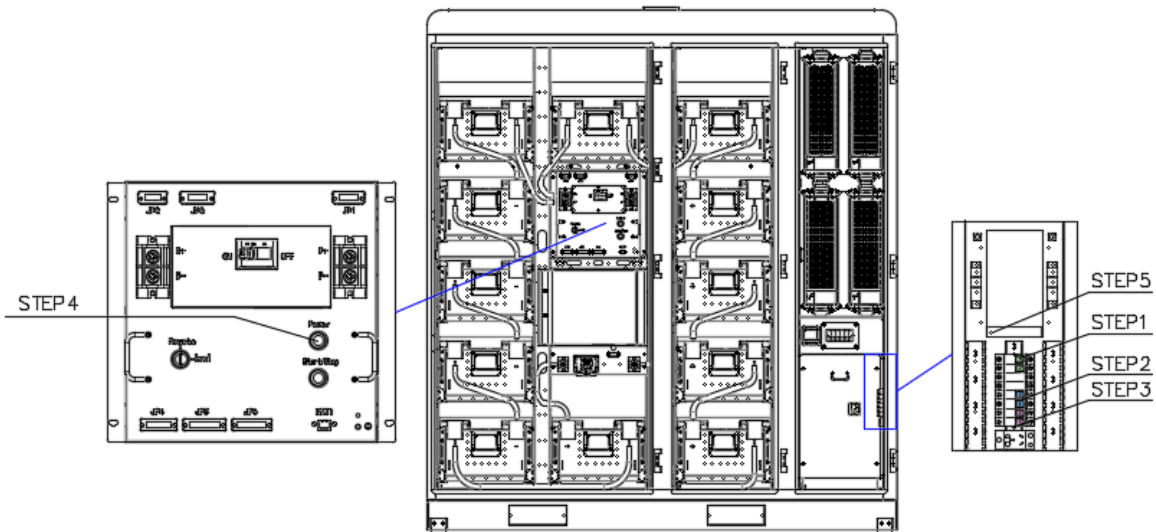

Fig. 5-6 Illustration of Secondary Circuit Off-Grid Connection Switch Positions

After the steps have been followed, check that the BESS High Voltage Control Box indicator lights are on. If the status of BESS is normal, the operation indicator light flashes, the fault indicator light and warning indicator light do not light up; then it enters the standby mode, please wait for receiving the external command.

5. 3 BESS Power-off Procedure

There are two power-down procedures for BESS according to the application scope:

- Secondary power supply power-down process is divided into 5 steps:

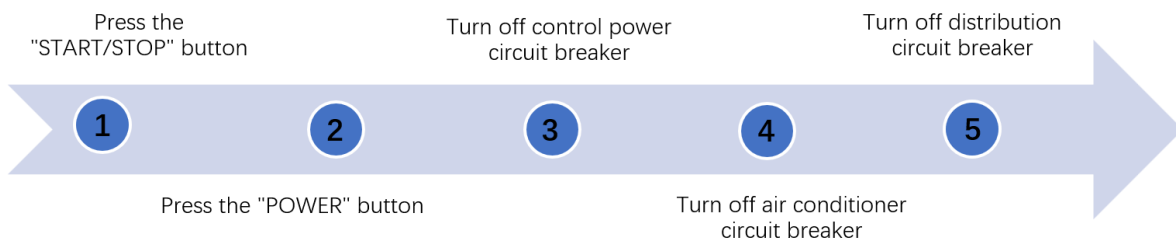

Fig. 5-7 BESS Secondary Power Supply Circuit Power-Down Process Procedure

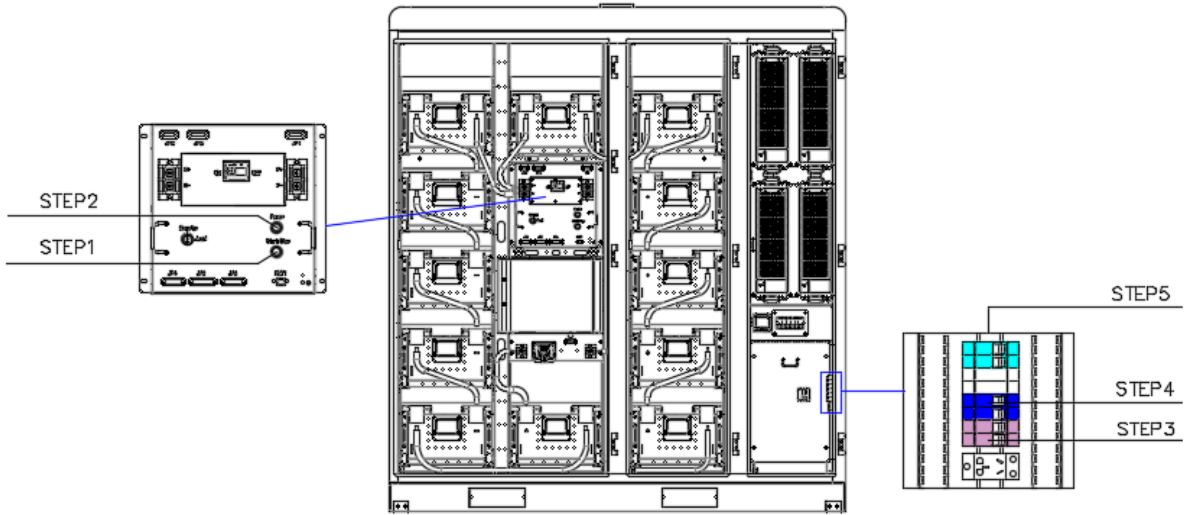

Fig. 5-8 BESS Secondary Power Circuit Power-Down Switch Positions

- When the main circuit is powered off for a long time, Power-down process is divided into 3 steps:

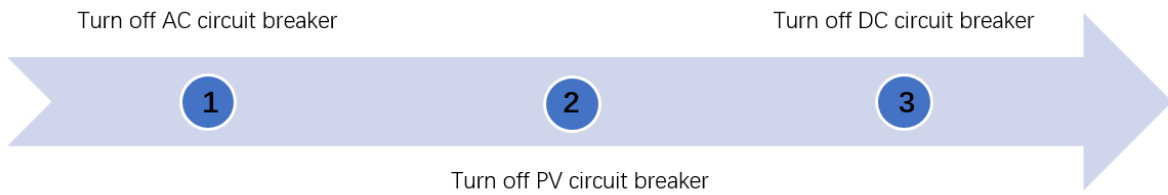

Fig. 5-9 BESS Main Loop Circuit Power-Down Procedure

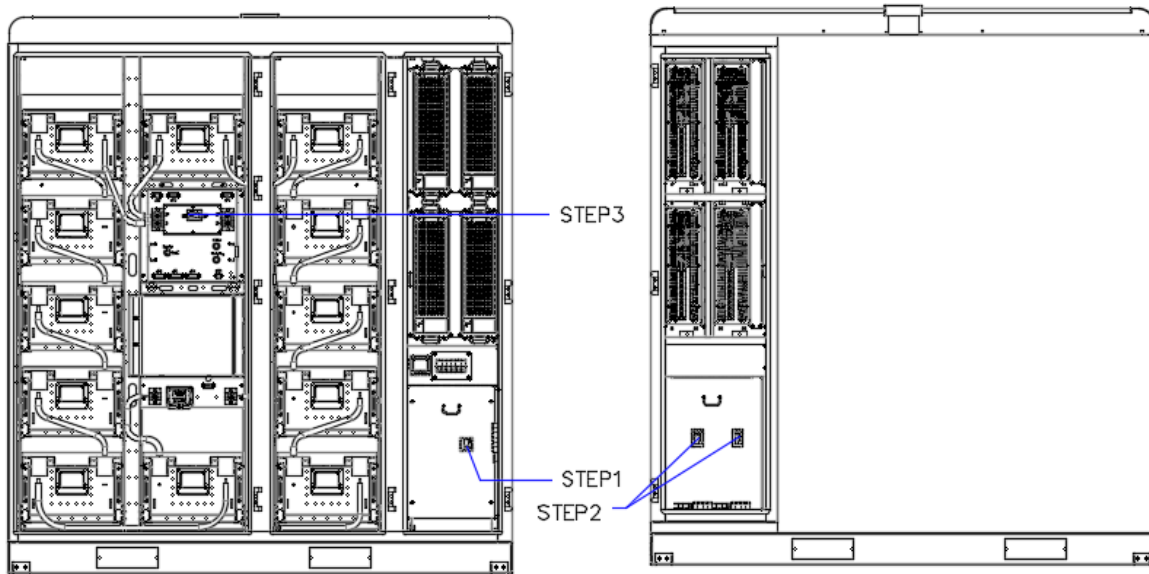

Fig. 5-10 BESS Main Loop Circuit Power- Down Switch Positions

After the steps are followed in sequence, the air conditioner and high-voltage control box will stop running, and the indicator light and screen of the BESS high-voltage control box will go out.

When the equipment is overhauled, the maintenance switch needs to be disconnected, and the maintenance and inspection of the equipment can be carried out after the equipment has been shut down for five minutes.

6 Commissioning

6.1 Local Startup

The equipment is in the power-on state (refer to 5.2 for the power-up process), check whether the equipment status is in the operation indicator blinking state, if yes, continue the following operation; if there is an alarm or fault in the product, enter the EMS interface, click on [Fault Alarm Information Page], take a picture of the fault information, and contact the distributor of the product to apply for after-sales service.

Put the mode switch of the control box in the "Local" state, press the "Start/Stop" button, the system will finish the self-start within 2 minutes.

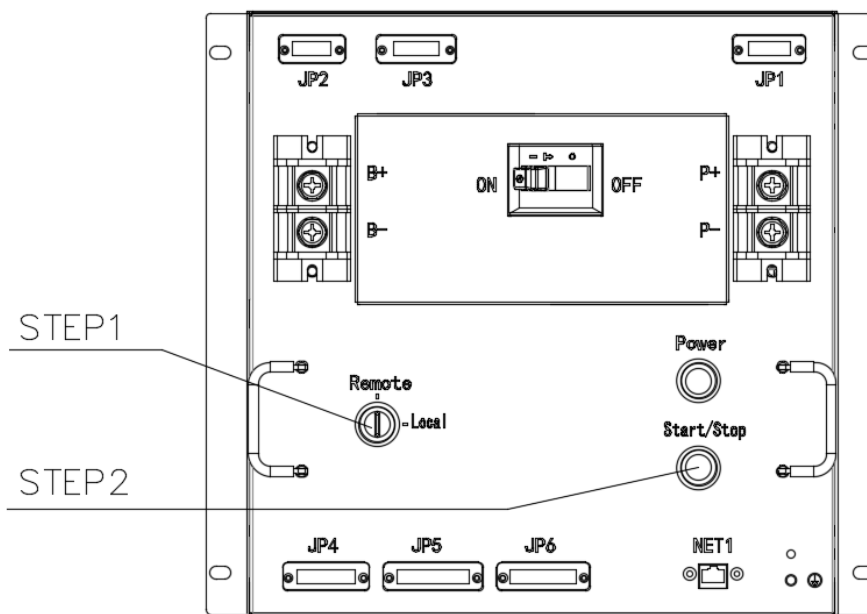

Fig. 6-1 Local Startup Operation Position

6.2 Communication Configuration

The device is powered on, set the mode switch of the control box to the "Remote" state, and connect the network cable to the computer.

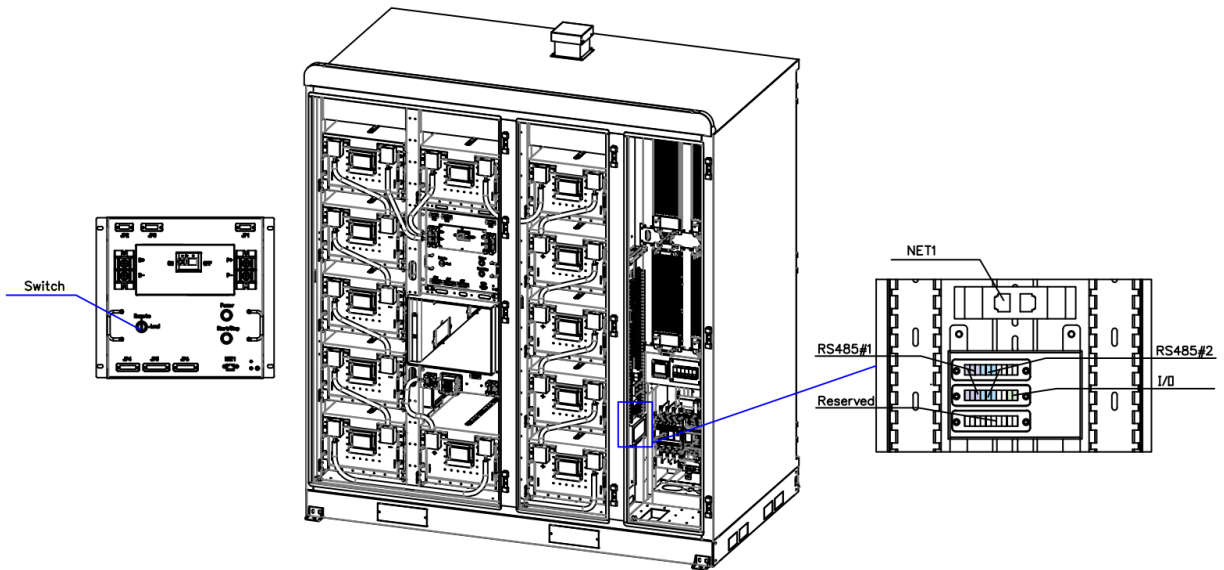

Fig. 6-2 Commissioning Interface Location

BESS supports the power scheduling function and is connected through a remote interface. The remote interface is divided into two types: TCP/IP and RS485. The relevant configurations are as follows:

- TCP / IP_IP : 192.168.1.100 或 192.168.1.100+n(Configuring the IP address)
- Device address: 1
- Port number: 502

RS485: Baud rate 38400 (485 serial port, one end connected to USB, one end connected to 485#2)

- Device address: 1
- Data bits: 8
- Check digit: No check
- Stop bit: 1

6.3 Scheduling Instructions

- Data reading and scheduling are carried out according to the product agreement, the main functions are start, stop, charge, discharge, etc. The detailed scheduling agreement is provided separately.
- After the input of the system start-stop command exceeds the limit, the system will not perform any action, nor will it modify the wrong command.
- After the system power input exceeds the limit, the system will actively modify the command to the maximum charge and discharge power.
- The system is fully charged, and the emptying stop is determined according to the voltage of a single cell. When the highest voltage is 3.55V, it is determined to be fully charged, and when the lowest voltage is 2.8V, it is determined to be empty. When the system is fully charged, the continuous delivery of charging power will not be executed, only the discharge power will be executed. When the system is empty, the continued power will not be executed, only the charging power will be executed. After filling and emptying, the limit will be automatically restored after the SOC changes due to the reverse power.
- If the system-level full and empty protection fails, the BMS-level full and empty protection will act, and manual recovery is required after the action.
- The system SOC is the reference value, which is calculated according to the battery configuration and current value, but the battery capacity and current value have errors, which are not accurate. Therefore, it is not recommended to use SOC as the judgment condition for full and empty for system scheduling.

7 Human-Computer Interaction

7.1 Local Use

1. After configuring the IP address of the computer, open Google Chrome to enter the "127.0.0.1" page, in the "Home" page shown in Figure 7-1, you can view the system's total operating information and conditions, and you can issue commands for the system's operating mode, start/stop, active power, and so on. The "Home" page, as shown in Figure 7-1, allows you to view the general operating information and situation of the system, and issue commands for the system's operating mode, start/stop, and active power.

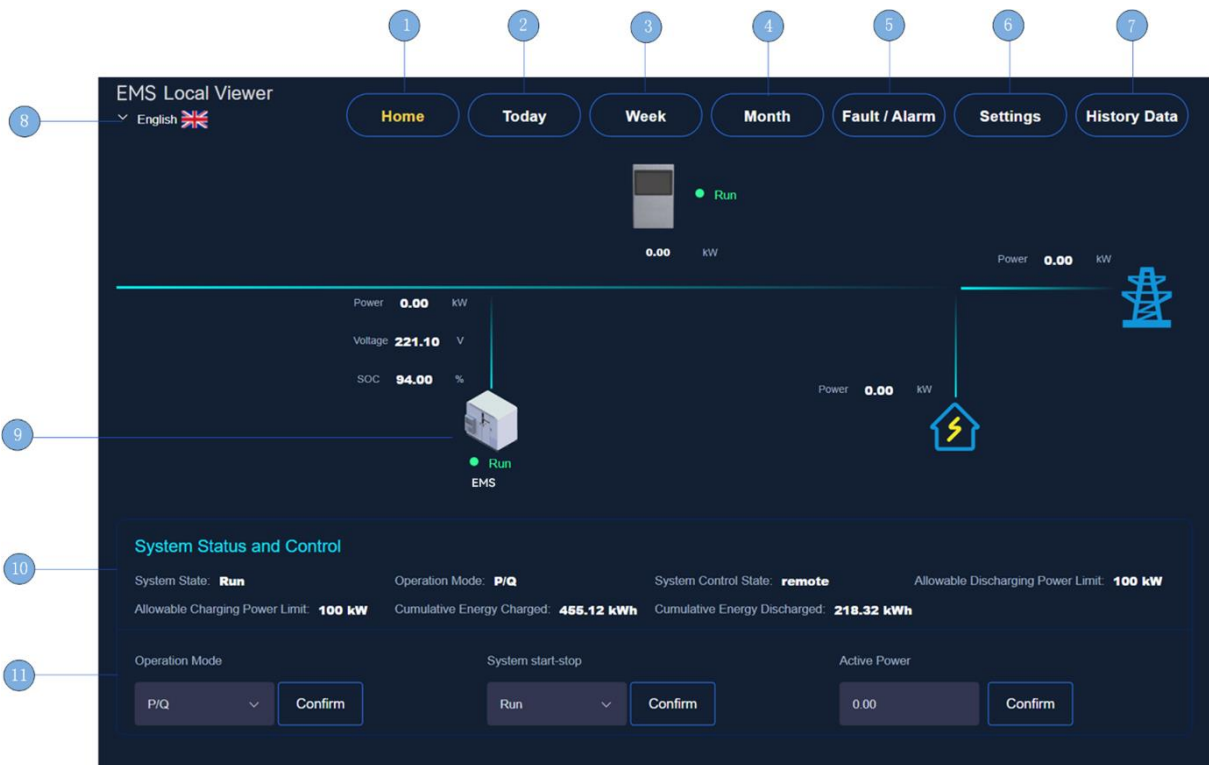

Fig. 7-1 Local Web System Main Page

Item	Name	Function	Remark
------	------	----------	--------

1	Home page button	Click the button to jump to the system home page	
2	Daily revenue page button	Click the button to jump to the system daily earnings information page	Options for Peak and Valley Modes
3	-Weekly revenue information page button	Click the button to jump to the system weekly earnings information page	Options for Peak and Valley Modes
4	Monthly revenue information page button	Click the button to jump to the system monthly earnings information page	Options for Peak and Valley Modes
5	Fault alarm information page button	Click the button to jump to the system fault alarm information page	
6	Parameter configuration page button	Click the button to jump to the system parameter configuration page	
7	Historical data information page button	Click the button to jump to the system historical data information page	
8	Language toggle button	Click the button to toggle the language displayed on the system page	
9	Specific device information page icon button	Click the button to jump to the specific device information page	
10	System status display	Real-time display of basic information such as system operation status and mode	
11	System state configuration	Configure basic information such as system running status and mode	



2. Click "Fault Alarm Information", that is, button 5, to enter the "System Fault Alarm Information" page, you can view the current equipment fault alarm information, click "View Historical Fault Information" to enter the historical fault alarm page, as shown in Figure 7-2. Click "View Historical Fault Information" to enter the historical fault alarm page, as shown in Figure 7-3. To enter the historical fault alarm page, you can select the date range to view the historical fault alarm information within the date range, click "View Current Fault Information" to return to the current fault alarm information page, as shown in Figure 7-3.

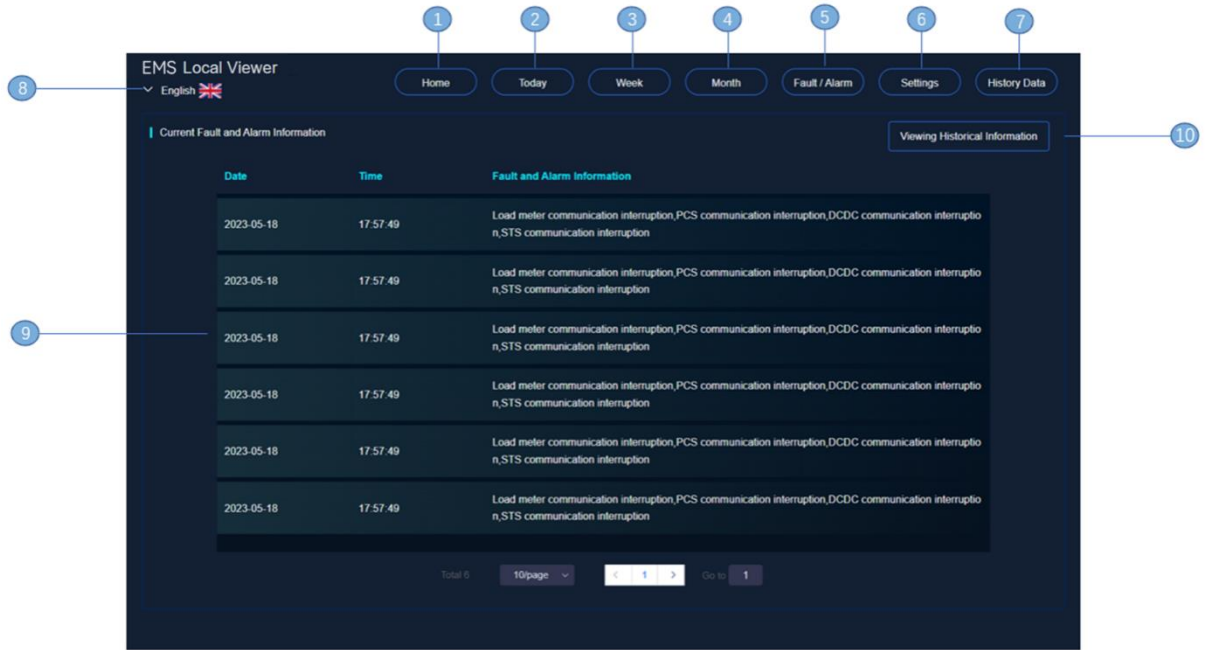

Fig. 7-2 Local Web System Current Fault Alarm Information Page

Item	Name	Function	Remark
1	Home page button	Click the button to jump to the system home page	
2	Battery information page button	Click the button to jump to the system battery information page	
3	Inverter information page button	Click the button to jump to the system inverter information page	
4	Photovoltaic information page button	Click the button to jump to the system photovoltaic information page	Optional
5	Fault alarm information page button	Click the button to jump to the system fault alarm information page	
6	Parameter configuration page button	Click the button to jump to the system parameter configuration page	
7	Historical data information page button	Click the button to jump to the system historical data information page	
8	Language toggle button	Click the button to toggle the language displayed on the system page	
9	Current fault alarm information	Real-time display of fault alarm information currently running of the system	
10	Toggle button on the historical fault alarm page	Click the button to go to the system history fault alarm information page	

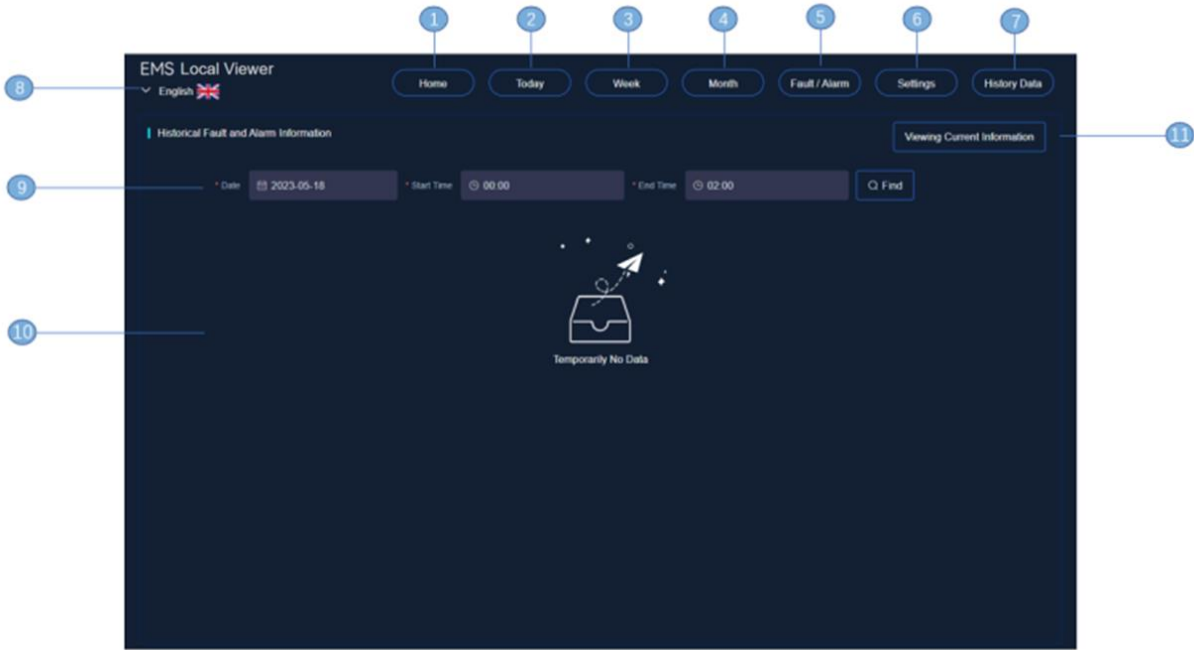

Fig. 7-3 Local web system history fault alarm information page

Item	Name	Function	Remark
1	Home page button	Click the button to jump to the system home page	
2	Battery information page button	Click the button to jump to the system battery information page	
3	Inverter information page button	Click the button to jump to the system inverter information page	
4	Photovoltaic information page button	Click the button to jump to the system photovoltaic information page	Optional
5	Fault alarm information page button	Click the button to jump to the system fault alarm information page	
6	Parameter configuration page button	Click the button to jump to the system parameter configuration page	
7	Current fault alarm information	Display the fault alarm information of the system operation during the time period	
8	Language toggle button	Click the button to toggle the language displayed on the system page	
9	Date selection box	Enter the fault alarm information during the selected display time	
10	Current fault alarm information	Displays the fault alarm information of the system during the time period	
11	Toggle the button on the current fault alarm page	Click the button to jump to the current fault alarm information page	

3. Click "Settings", that is, button 6, to enter the "Settings" page, you can configure some of the system's operating parameters, as well as to view the current version of the system's various modules of the program information, as shown in Figure 7-4.

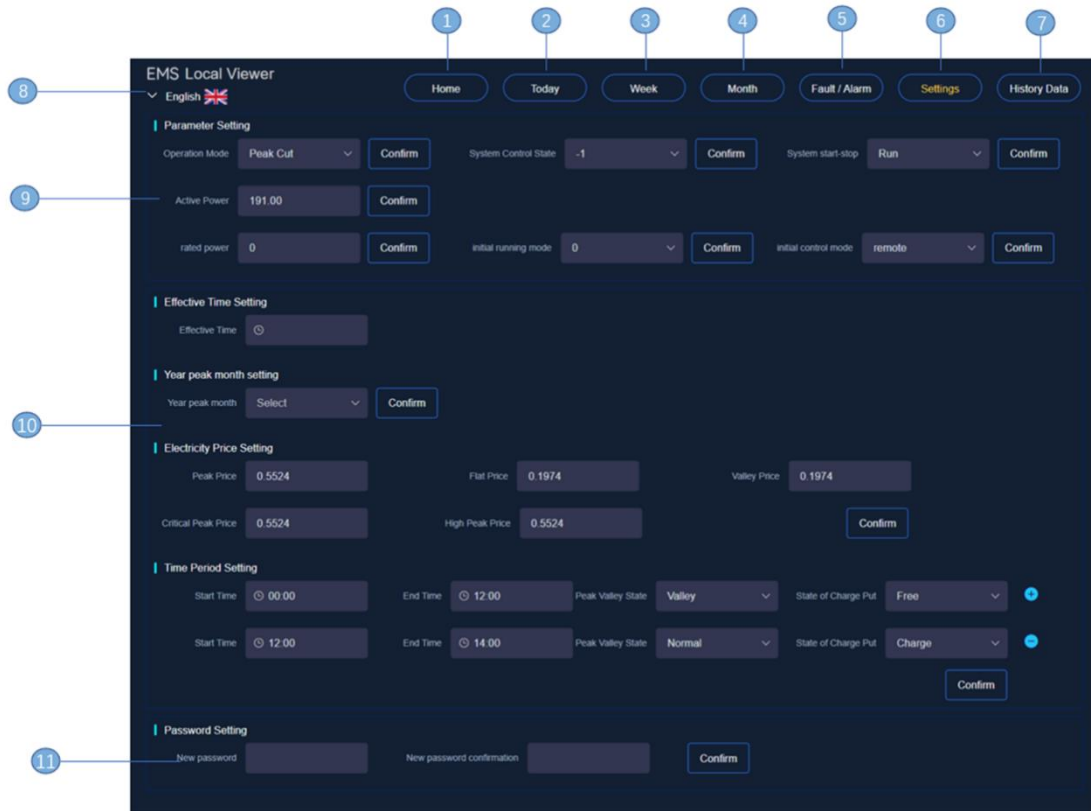

Fig. 7-4 Local Web System Parameter Settings Page

Item	Name	Function	Remark
1	Home page button	Click the button to jump to the system home page	
2	Battery information page button	Click the button to jump to the system battery information page	
3	Inverter information page button	Click the button to jump to the system inverter information page	
4	Photovoltaic information page button	Click the button to jump to the system photovoltaic information page	Optional
5	Fault alarm information page button	Click the button to jump to the system fault alarm information page	
6	Parameter configuration page button	Click the button to jump to the system parameter configuration page	

7	Historical data information page button	Click the button to jump to the system historical data information page	
8	Language toggle button	Click the button to toggle the language displayed on the system page	
9	System parameter configuration	Configure the basic information such as the primary system operation status and mode	
10	Peak-valley operating status settings	Set the system peak and valley operating hours, electricity prices and other information	
11	Password settings	Set the operation Enter password, super password: 88888888	

●

4. Click the "Historical Data" button, i.e., button 7, to enter the "System Historical Data View and Export" page, you can view and export the historical data of the system operation.

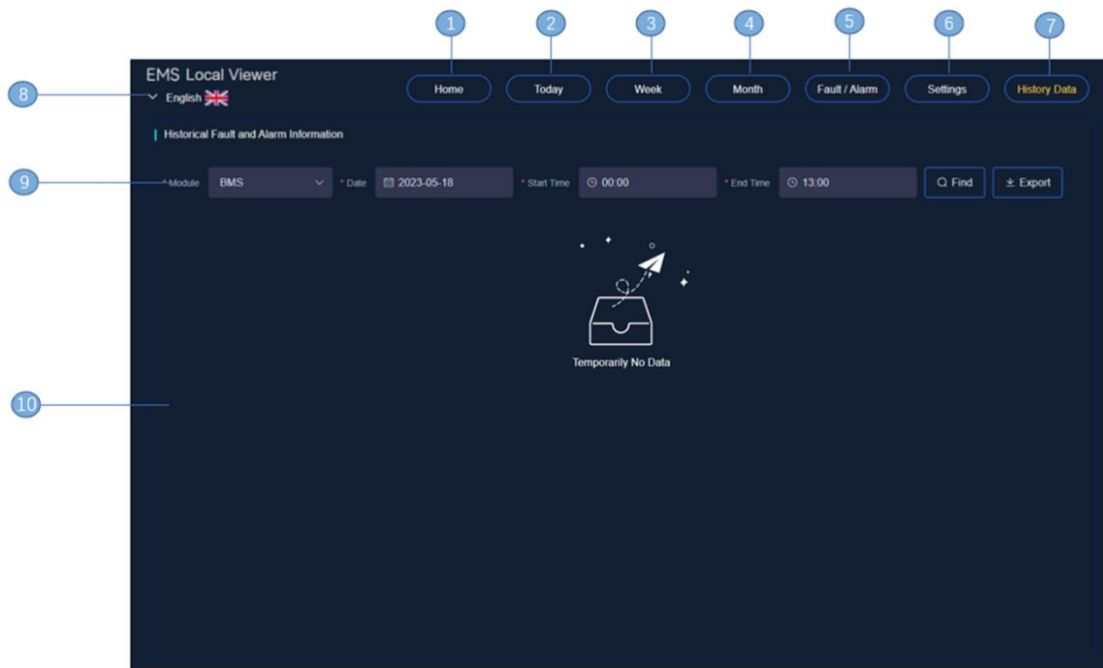

●

Fig. 7-5 Local Web System Historical Data Information Page

Item	Name	Function	Remark
1	Home page button	Click the button to jump to the system home page	

2	Battery information page button	Click the button to jump to the system battery information page	
3	Inverter information page button	Click the button to jump to the system inverter information page	
4	Photovoltaic information page button	Click the button to jump to the system photovoltaic information page	Optional
5	Fault alarm information page button	Click the button to jump to the system fault alarm information page	
6	Parameter configuration page button	Click the button to jump to the system parameter configuration page	
7	Historical data information page button	Click the button to jump to the system historical data information page	
8	Language toggle button	Click the button to toggle the language displayed on the system page	
9	Date selection box	Enter the fault alarm information during the selected display time	
10	Current fault alarm information	Displays the fault alarm information of the system during the time period	

5. In the system home page, click on the specific device icon button (i.e., icon button "9" in Figure 7-1), you can enter the specific device operation information page, enter the first "home" page, you can view the system's total operation information and situation, as shown in Figure 7-6. The first "Home" page can be accessed to view the total system operation information and situation, as shown in Figure 7-6.

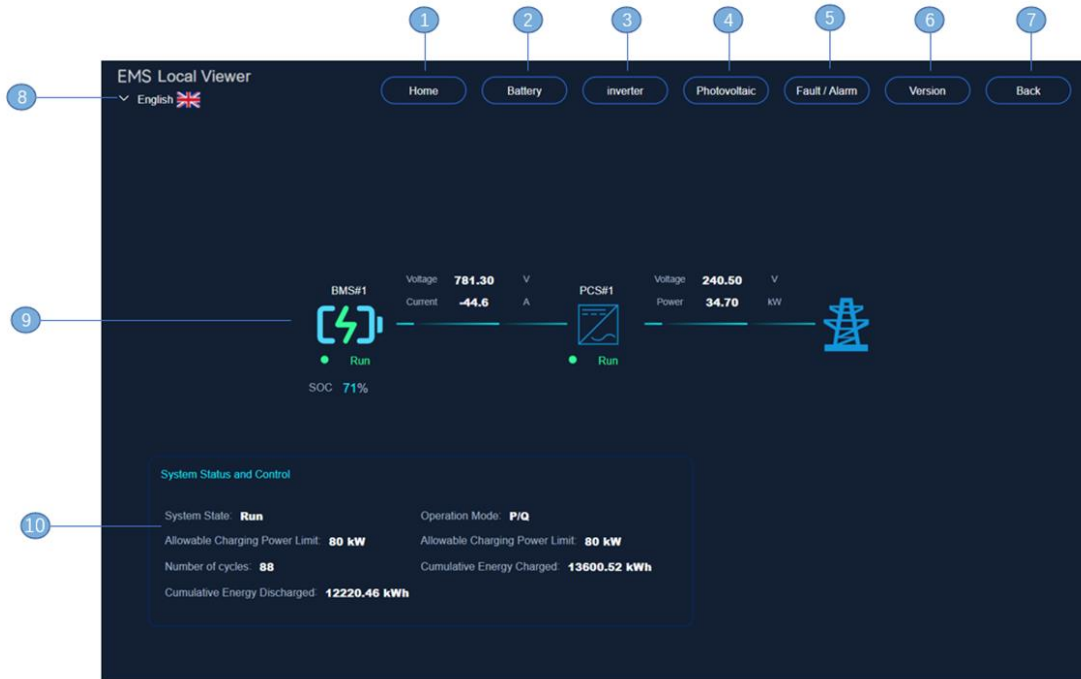

Fig. 7-6 Local Web System Home Page Information Page

Item	Name	Function	Remark
1	Home page button	Click the button to jump to the system home page	
2	Battery information page button	Click the button to jump to the system battery information page	
3	Inverter information page button	Click the button to jump to the system inverter information page	
4	Photovoltaic information page button	Click the button to jump to the system photovoltaic information page	Optional
5	Fault alarm information page button	Click the button to jump to the system fault alarm information page	
6	Program version information page button	Click the button to jump to the program version information page for the selected device	
7	Page back button	Click the button to jump to the main page of the energy storage system, which is the Figure 1 page	
8	Language toggle button	Click the button to toggle the language displayed on the system page	
9	Home page system module status	Real-time display of the operating status and basic parameters of each module of the system	

10	System status display	Real-time display of basic information such as system operation status and mode	
----	-----------------------	---	--



6. Click the "Battery Information" button, i.e., button 2, to enter the specific device battery information page, you can view the specific operation of the battery, the weapon can select the date to view the battery's SOC and battery pack current, Figure 7-7 shows.

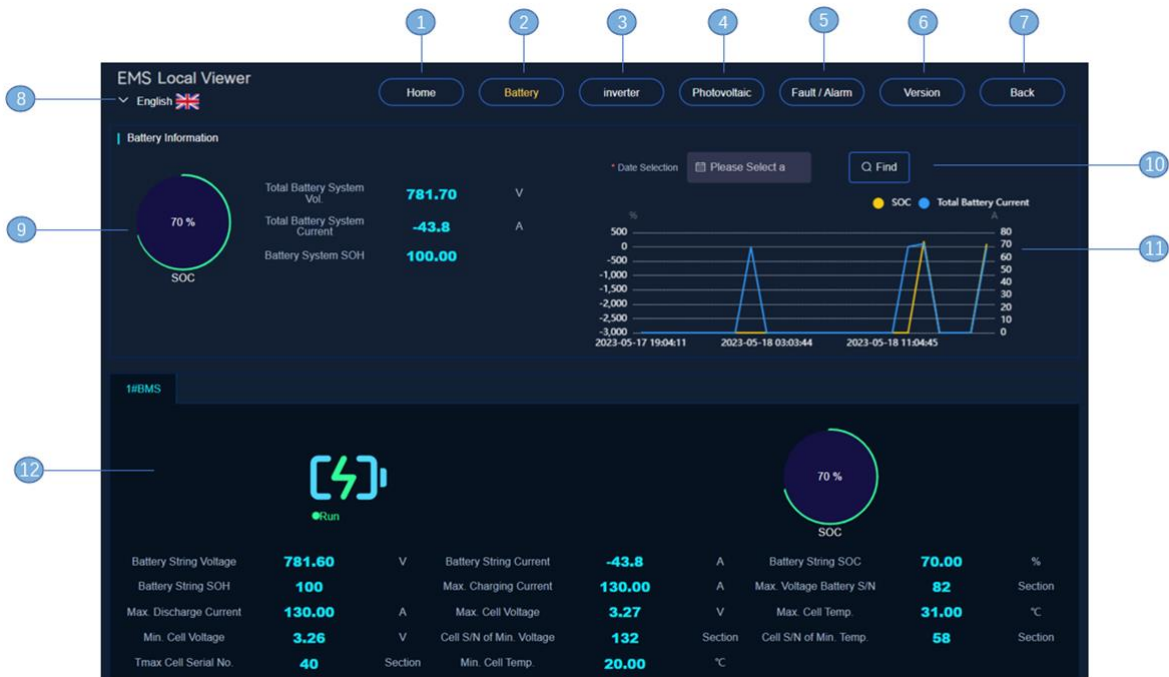

Fig. 7-7 Local web system battery information page

Item	Name	Function	Remark
1	Home page button	Click the button to jump to the system home page	
2	Battery information page button	Click the button to jump to the system battery information page	
3	Inverter information page button	Click the button to jump to the system inverter information page	
4	Photovoltaic information page button	Click the button to jump to the system photovoltaic information page	Optional
5	Fault alarm information page button	Click the button to jump to the system fault alarm information page	

6	Program version information page button	Click the button to jump to the program version information page for the selected device	
7	Page back button	Click the button to jump to the main page of the energy storage system, which is the Figure 7-1 page	
8	Language toggle button	Click the button to toggle the language displayed on the system page	
9	Battery stack information	Real-time display of stack operation information	
10	Date selection box	Enter the Select Battery Operation infographic for the show time	
11	Battery operation infographic	When the user does not make a selection input, the SOC and battery current curves over a 24-hour period are displayed	
12	Individual battery cluster information	Real-time display of battery cluster operation information	

7. Click the "Inverter Information" button, i.e., button 3, to enter the Inverter Information page, which allows you to view the specific operation of the inverter, and you can select the date to view the AC active power of the PCS, as shown in Figure 7-8.

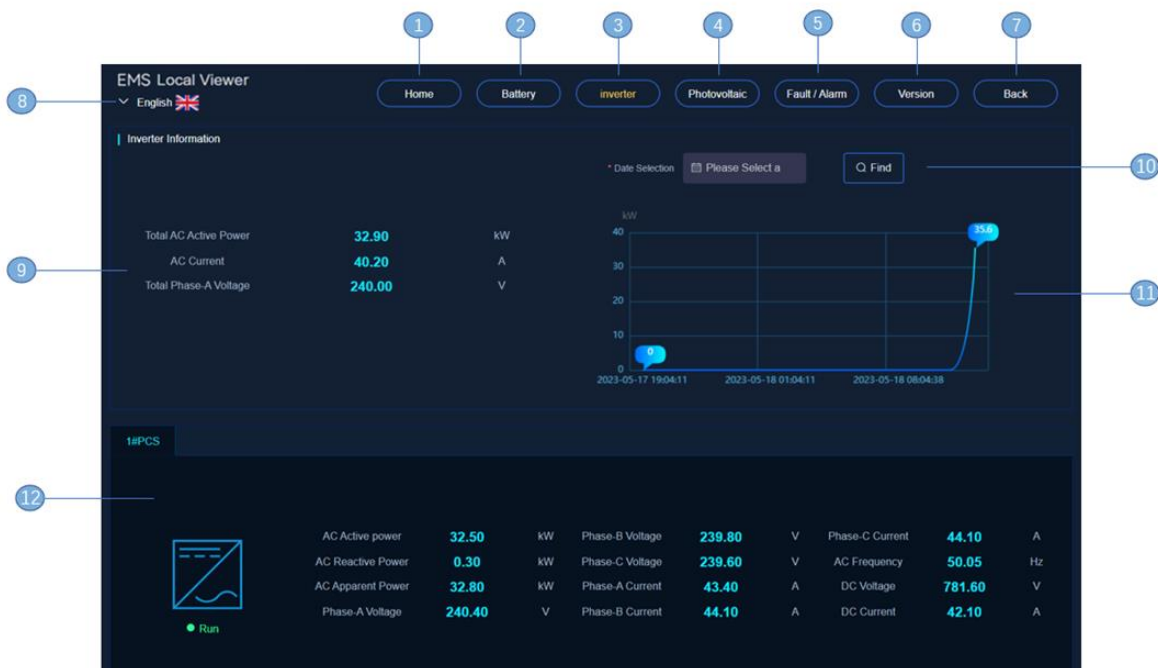

Fig. 7-8 Local web system inverter information page

Item	Name	Function	Remark
1	Home page button	Click the button to jump to the system home page	
2	Battery information page button	Click the button to jump to the system battery information page	
3	Inverter information page button	Click the button to jump to the system inverter information page	
4	Photovoltaic information page button	Click the button to jump to the system photovoltaic information page	Optional
5	Fault alarm information page button	Click the button to jump to the system fault alarm information page	
6	Program version information page button	Click the button to jump to the program version information page for the selected device	
7	Page back button	Click the button to jump to the main page of the energy storage system, which is the Figure 7-1 page	
8	Language toggle button	Click the button to toggle the language displayed on the system page	
9	Battery stack information	Real-time display of stack operation information	
10	Date selection box	Enter the Select Battery Operation infographic for the show time	
11	Inverter operation infographic	When the user does not make a selection input, the AC active power change curve over a 24-hour period is displayed	
12	Individual inverter information	Real-time display of the operation information of a single inverter	



8. Click on the "Photovoltaic" button, i.e., button 4, to enter the PV Information page, which allows you to view the specific operation of the PV, and you can select the date to view the PV current and power information.

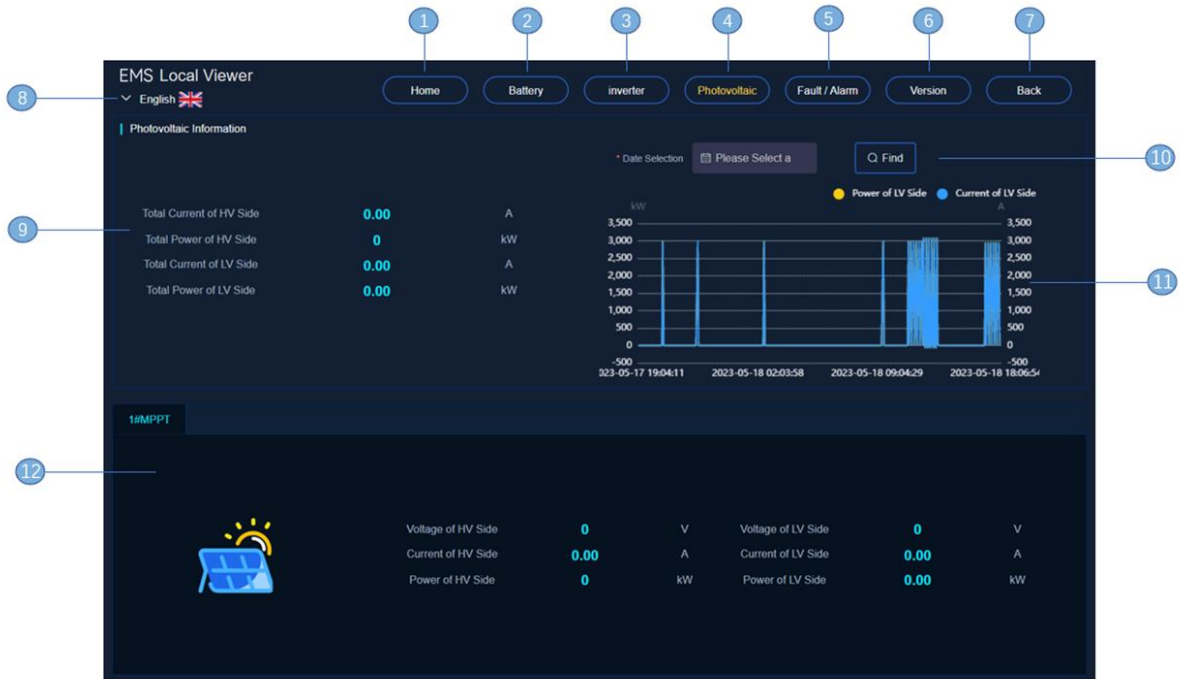

Fig. 7-9 Local web system PV information page

Item	Name	Function	Remark
1	Home page button	Click the button to jump to the system home page	
2	Battery information page button	Click the button to jump to the system battery information page	
3	Inverter information page button	Click the button to jump to the system inverter information page	
4	Photovoltaic information page button	Click the button to jump to the system photovoltaic information page	Optional
5	Fault alarm information page button	Click the button to jump to the system fault alarm information page	
6	Program version information page button	Click the button to jump to the program version information page for the selected device	
7	Page back button	Click the button to jump to the main page of the energy storage system, which is the Figure 7-1 page	
8	Language toggle button	Click the button to toggle the language displayed on the system page	
9	General PV information	Real-time display of total PV operation information	
10	Date selection box	Enter the Select Battery Operation infographic for the show time	

11	PV operation infographic	When the user does not make a selection input, the AC active power change curve over a 24-hour period is displayed	
12	Individual PV information	Real-time display of the operation information of a single PV	



9. Click "Version ", i.e., button 6, to enter the program version information page, you can view the version information of each module program of the current system.

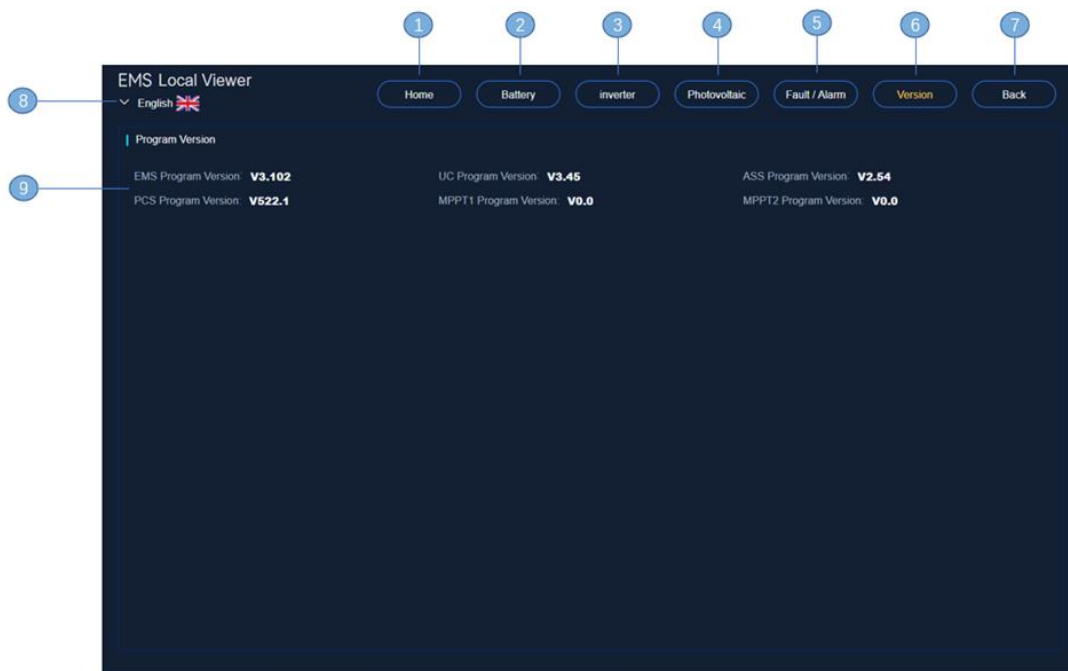

Fig. 7-10 Local web system version information page

Item	Name	Function	Remark
1	Home page button	Click the button to jump to the system home page	
2	Battery information page button	Click the button to jump to the system battery information page	
3	Inverter information page button	Click the button to jump to the system inverter information page	
4	Photovoltaic information page button	Click the button to jump to the system photovoltaic information page	Optional
5	Fault alarm information page button	Click the button to jump to the system fault alarm information page	

6	Program version information page button	Click the button to jump to the program version information page for the selected device	
7	Page back button	Click the button to jump to the main page of the energy storage system, which is the Figure 7-1 page	
8	Language toggle button	Click the button to toggle the language displayed on the system page	
9	System program version information	Displays the program version information of each module running in the system	

10. Click the "Today" button, i.e., button 2, to enter the "Daily Revenue Information" page, where you can view the charging volume, revenue, tariff, and other information of the current day.

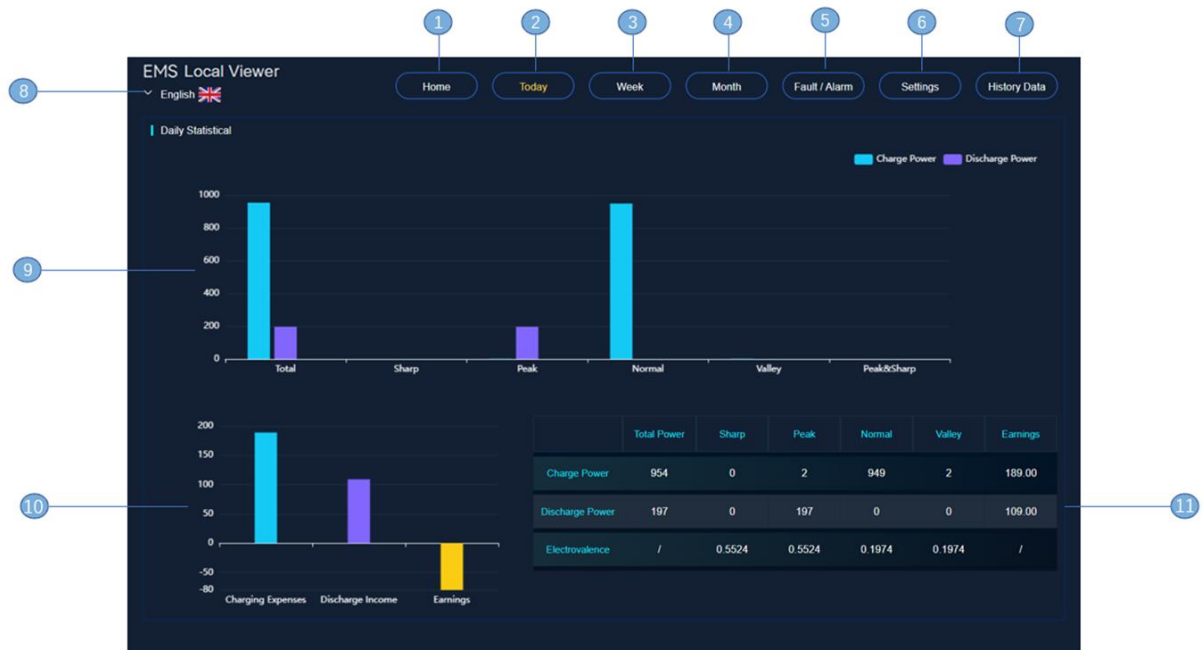

Fig. 7-11 Local Web System Daily Earnings Information Page

Item	Name	Function	Remark
1	Home page button	Click the button to jump to the system home page	
2	Daily revenue information page button	Click the button to jump to the system daily earnings information page	Options for Peak and Valley Modes

3	Weekly revenue information page button	Click the button to jump to the system weekly earnings information page	Options for Peak and Valley Modes
4	Monthly revenue information page button	Click the button to jump to the system monthly earnings information page	Options for Peak and Valley Modes
5	Fault alarm information page button	Click the button to jump to the system fault alarm information page	
6	Parameter configuration page button	Click the button to jump to the system parameter configuration page	
7	Historical data information page button	Click the button to jump to the system historical data information page	
8	Language toggle button	Click the button to toggle the language displayed on the system page	
9	Time period electricity information display	Real-time display of the system's peak and valley peak and valley charging and discharging information during normal hours	
10	Revenue display	Real-time display of the system charging and discharging income information of the day	
11	Daily operation data display	Real-time display of the system daily electricity price, time period electricity and other basic information	

11. Click "Week", i.e., button 3, to enter the "Weekly Profit Information" page, where you can check the charging volume, profit and other information of this weeks'time slot.



Fig. 7-12 Local Web System This Week's Earnings Information Page

Item	Name	Function	Remark
1	Home page button	Click the button to jump to the system home page	
2	Daily revenue information page button	Click the button to jump to the system daily earnings information page	Options for Peak and Valley Modes
3	Monthly revenue information page button	Click the button to jump to the system weekly earnings information page	Options for Peak and Valley Modes
4	Monthly revenue information page button	Click the button to jump to the system monthly earnings information page	Options for Peak and Valley Modes
5	Fault alarm information page button	Click the button to jump to the system fault alarm information page	
6	Parameter configuration page button	Click the button to jump to the system parameter configuration page	
7	Historical data information page button	Click the button to jump to the system historical data information page	
8	Language toggle button	Click the button to toggle the language displayed on the system page	
9	Electricity revenue chart display	Real-time display of the system's charge and discharge volume income chart in the past week	

10	Electricity revenue table display	Real-time display of the system's charge and discharge revenue table for the past week	
----	-----------------------------------	--	--

12. Click the "Month" button, i.e., button 4, to enter the "Monthly Profit Information" page, you can view the information of charging volume and profit for this month and last month. The monthly revenue information is shown in Figure 7-13:



Fig. 7-13 Local Web System Monthly Earnings Information Page

Item	Name	Function	Remark
1	Home page button	Click the button to jump to the system home page	
2	Daily revenue information page button	Click the button to jump to the system daily earnings information page	Options for Peak and Valley Modes
3	Monthly revenue information page button	Click the button to jump to the system weekly earnings information page	Options for Peak and Valley Modes
4	Monthly revenue information page button	Click the button to jump to the system monthly earnings information page	Options for Peak and

			Valley Modes
5	Fault alarm information page button	Click the button to jump to the system fault alarm information page	
6	Parameter configuration page button	Click the button to jump to the system parameter configuration page	
7	Historical data information page button	Click the button to jump to the system historical data information page	
8	Language toggle button	Click the button to toggle the language displayed on the system page	
9	This month's electricity revenue chart displays	Real-time display of the system's charge and discharge volume income chart in the past month	
10	Last month's electricity revenue chart display	Real-time display of the system's charge and discharge revenue chart in the past month	
11	Electricity revenue table display	Real-time display of the system's charge and discharge revenue table for this month and last month	

※Note: [The Today], [The Week], and [The Month] income pages belong to the peak and valley mode, and other modes do not have this part.

7. 2 External devices via network cable connection

1. Use a network cable to connect the external device to the industrial personal computer, or connect the external device to the industrial personal computer to the same Wi-Fi, so that the external device and the industrial personal computer are in the same local area network, and then after the external device enters the "Network and Internet", select "Ethernet" after selecting "Windows Firewall", select "Public Network", enter and turn off the firewall in the industrial personal computer. As shown in Figure 7-14~7-16.



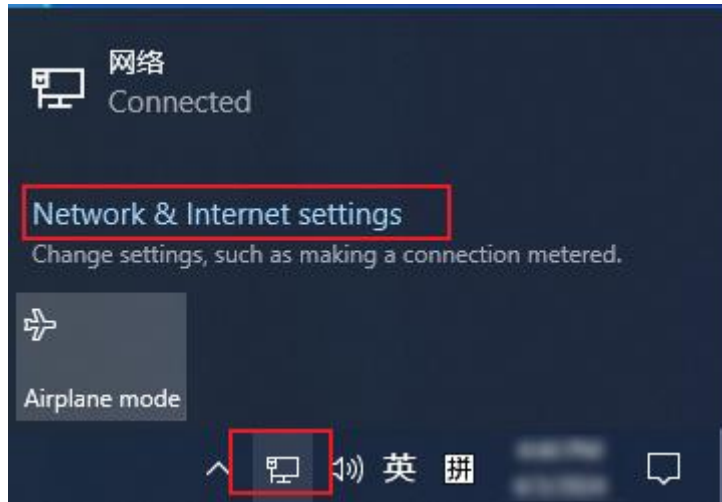

Fig. 7-13 Network and Internet Settings

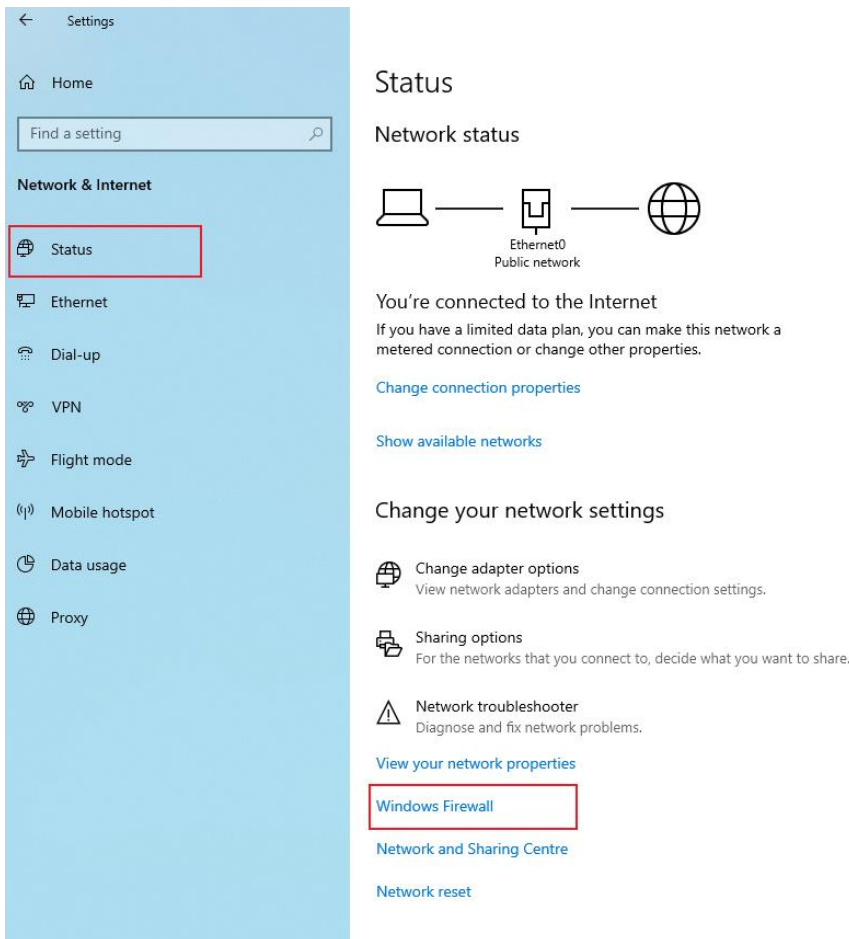

Fig. 7-14 Firewall Settings 1

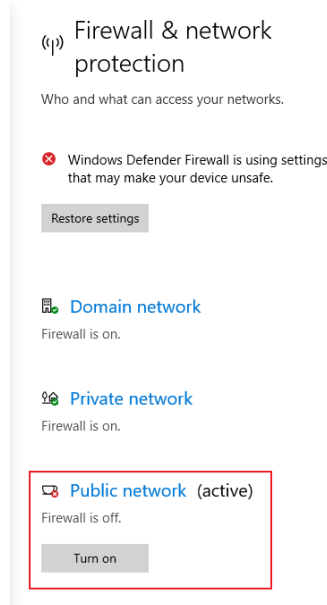

Fig. 7-15 Firewall Settings 2

2. In the external device, open the browser, enter "192.168.1.200" in the URL search, enter the web page, check the data, the data should be consistent with the data of the industrial personal computer, and the operation mode is the same as the industrial personal computer access. As shown in Figure 7-4.

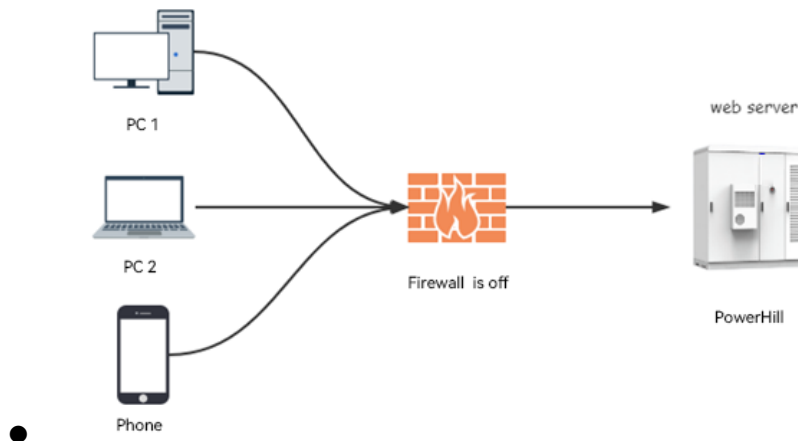

Fig. 7-16 External Browser Access

Note:

1. When accessing external devices such as PCS, the external devices need to be on the same network segment as the IP of the industrial computer: 192.168.1.xxx. 2;

2. And in this network segment, not in addition to the industrial control machine IP "192.168.1.200" device, otherwise the communication will fail; Confirmation method:

Disconnect the industrial computer, PC keyboard input "Win + R" key, pop-up run box, type "cmd", confirm, open the "Command Prompt", enter "ping 192.168.1.200" to query whether there is a device with IP "192.168.1.200" in the current network segment, if it succeeds, it means that there is this IP in the network segment, and you need to modify the IP again to avoid the IP of other devices being the same as that of the industrial control machine. Other devices with the same IP as the industrial computer, if it fails, it can be directly connected to the industrial computer for use, communication success and failure page can refer to Figure 7-17 and Figure 7-18.

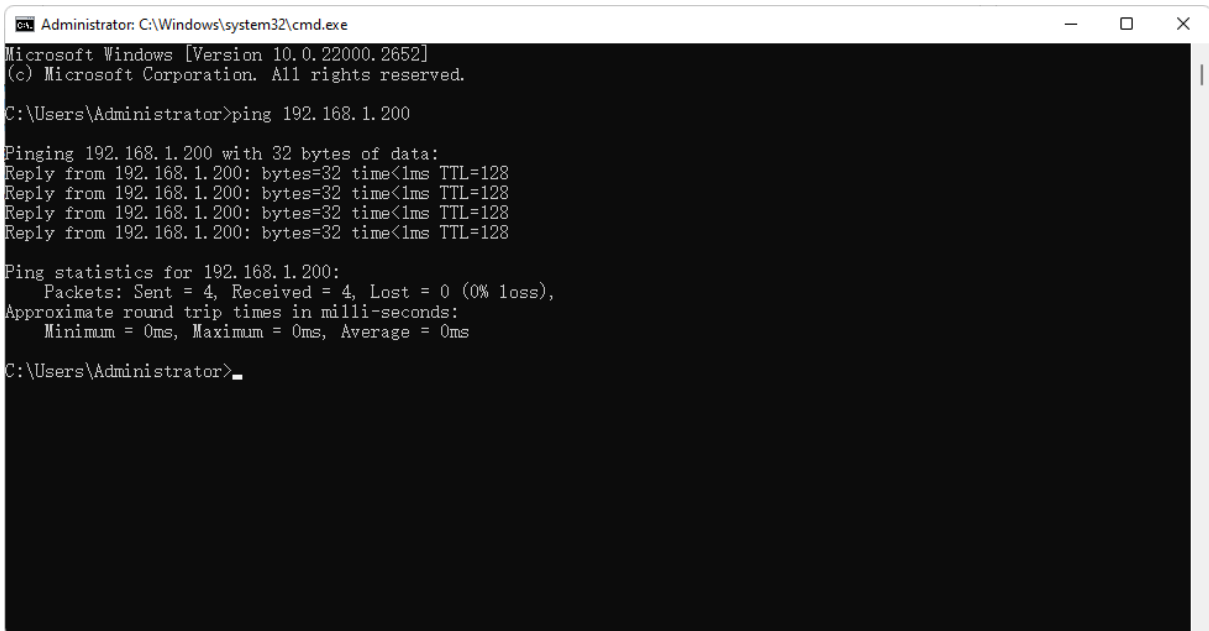

```

Administrator: C:\Windows\system32\cmd.exe
Microsoft Windows [Version 10.0.22000.2652]
(c) Microsoft Corporation. All rights reserved.

C:\Users\Administrator>ping 192.168.1.200

Pinging 192.168.1.200 with 32 bytes of data:
Reply from 192.168.1.200: bytes=32 time<1ms TTL=128
Reply from 192.168.1.200: bytes=32 time<1ms TTL=128
Reply from 192.168.1.200: bytes=32 time<1ms TTL=128
Reply from 192.168.1.200: bytes=32 time<1ms TTL=128

Ping statistics for 192.168.1.200:
    Packets: Sent = 4, Received = 4, Lost = 0 (0% loss),
    Approximate round trip times in milli-seconds:
        Minimum = 0ms, Maximum = 0ms, Average = 0ms

C:\Users\Administrator>_
    
```

Fig. 7-17 Communication Success Page

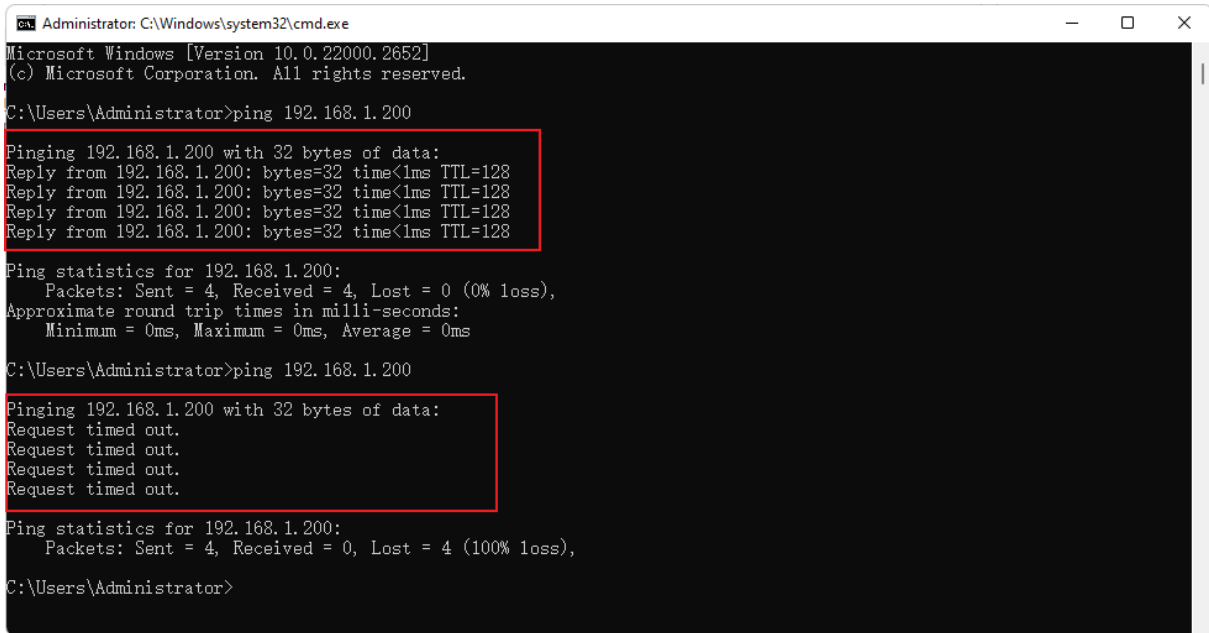

```
Administrator: C:\Windows\system32\cmd.exe
Microsoft Windows [Version 10.0.22000.2652]
(c) Microsoft Corporation. All rights reserved.

C:\Users\Administrator>ping 192.168.1.200

Pinging 192.168.1.200 with 32 bytes of data:
Reply from 192.168.1.200: bytes=32 time<1ms TTL=128
Reply from 192.168.1.200: bytes=32 time<1ms TTL=128
Reply from 192.168.1.200: bytes=32 time<1ms TTL=128
Reply from 192.168.1.200: bytes=32 time<1ms TTL=128

Ping statistics for 192.168.1.200:
    Packets: Sent = 4, Received = 4, Lost = 0 (0% loss),
    Approximate round trip times in milli-seconds:
        Minimum = 0ms, Maximum = 0ms, Average = 0ms

C:\Users\Administrator>ping 192.168.1.200

Pinging 192.168.1.200 with 32 bytes of data:
Request timed out.
Request timed out.
Request timed out.
Request timed out.

Ping statistics for 192.168.1.200:
    Packets: Sent = 4, Received = 0, Lost = 4 (100% loss),

C:\Users\Administrator>
```

Fig. 7-18 Communication Failure page

8 Contact details

Company Name: Dunext Technology Co., Ltd.

Website: www.Dunext.com

Address: No. 88 Nanxijiang Road, Wuzhong District, Suzhou City, Jiangsu Province,
China.

Contact: +86 0512 68789880



Innovate for a Green Future

Dunext Technology Co., Ltd.

 No. 88 Nanxijiang Road, Wuzhong District, Suzhou City, Jiangsu Province, China

 info@dunext.com

 www.dunext.com